

# THRONE

**A**

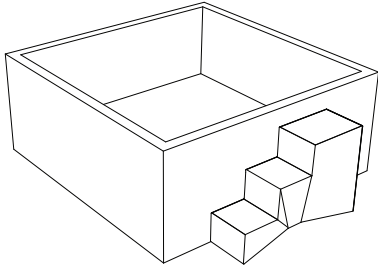

**A + B**

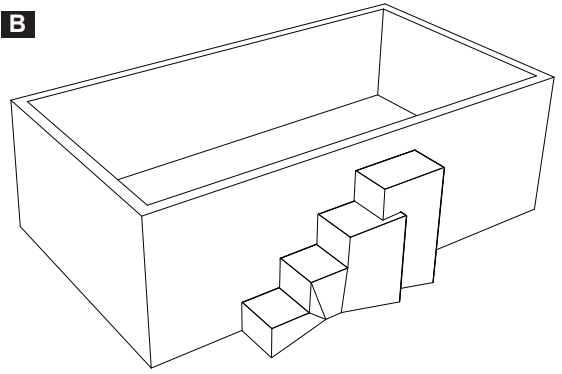

*Technical drawing*

**A**

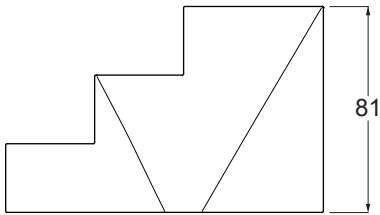

**B**

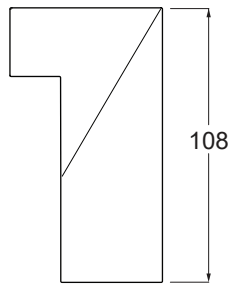

**A + B**

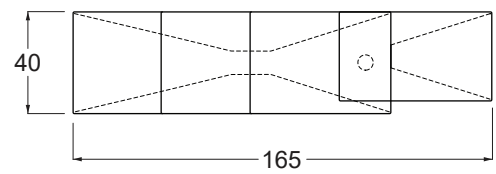
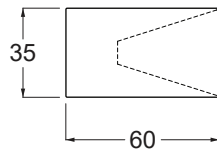
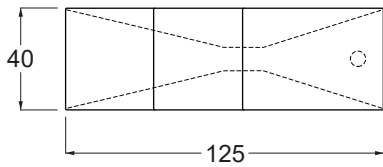
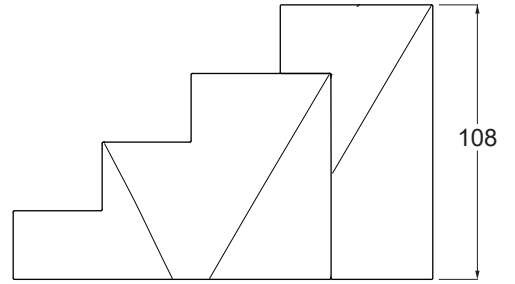

*Installations allowed*

