

CASA BIUI

STRATA SS



GENERAL INFORMATION

CASA BLUI – STRATA

Capacity: 2 people

Seating positions: 4 positions

Dimensions: 95" x 69" x 33"

Discover Strata, a premium intimate spa designed for deep connection and restorative solitude. Engineered for those who value mindful living, its ergonomic contours invite you to unwind in a space that feels both expansive and comfortably enclosed.

Experience the art of hydrotherapy with sleek stainless-steel jets that offer a powerful, yet smooth full-body massage. We prioritize your well-being with advanced filtration technology designed to maintain crystal-clear water, ensuring every soak is fresh and pristine. With effortless digital controls at your fingertips, you can curate your perfect temperature and mood in seconds.

With its minimalist profile and modern aesthetic, the Strata transcends the traditional hot tub—it is an architectural statement that turns your home into a daily wellness ritual.





TECHNICAL SPECIFICATIONS

Dimensions:	95" x 69" x 33"
Water Capacity:	800 L
Dry Weight:	1300 lbs
Filled Weight:	3100 lbs
Power Requirement:	50A - 220V/60Hz
Water Massage Pump:	3 HP
Circulation Pump:	0.5 kW
Water Heater:	5.5 kW
Filter Type:	Cartridge
Display:	Balboa SpaTouch 4

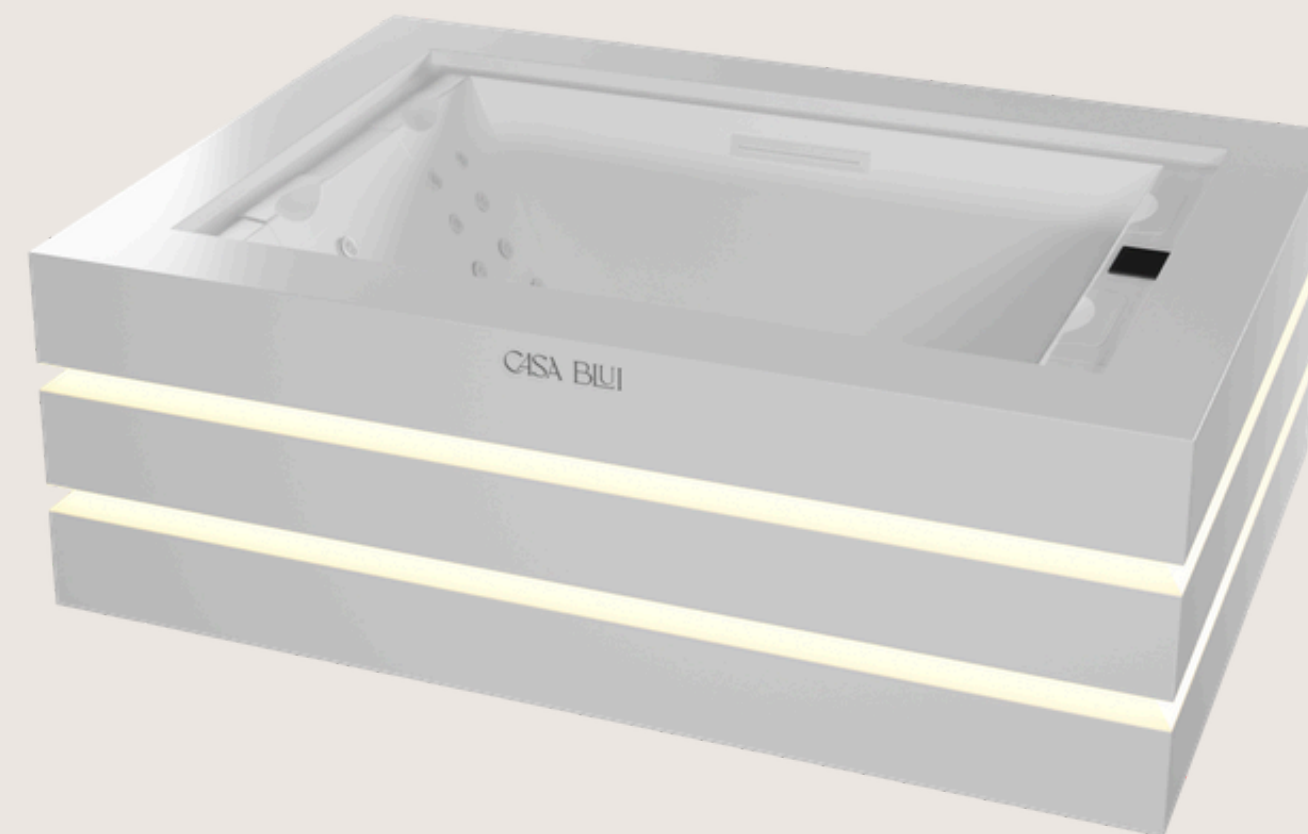



TECHNICAL DRAWINGS

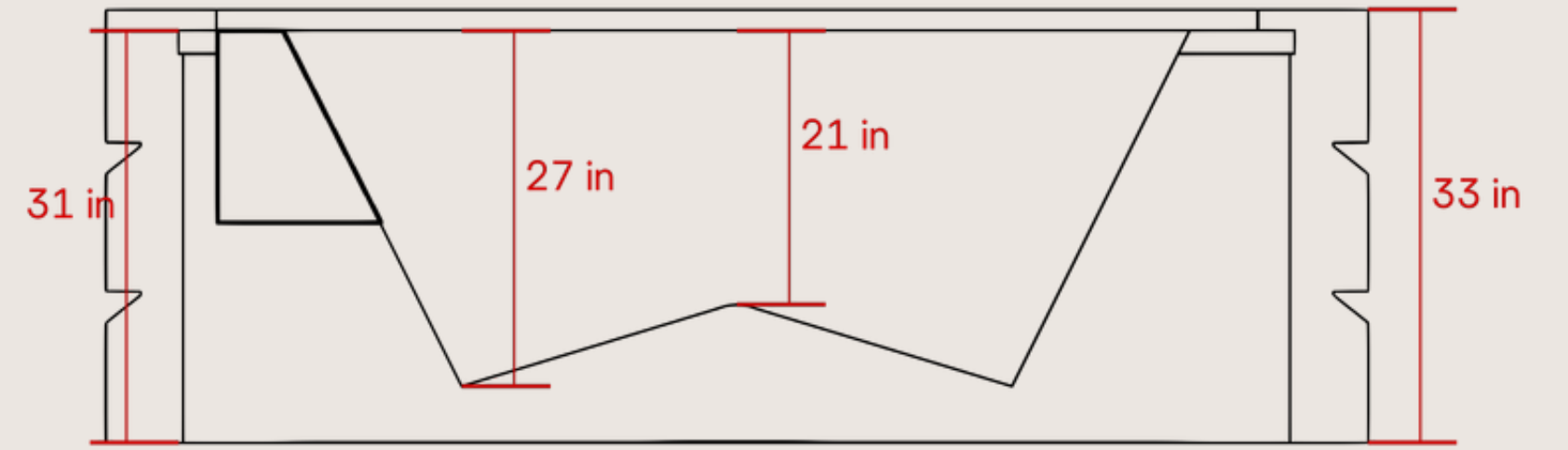
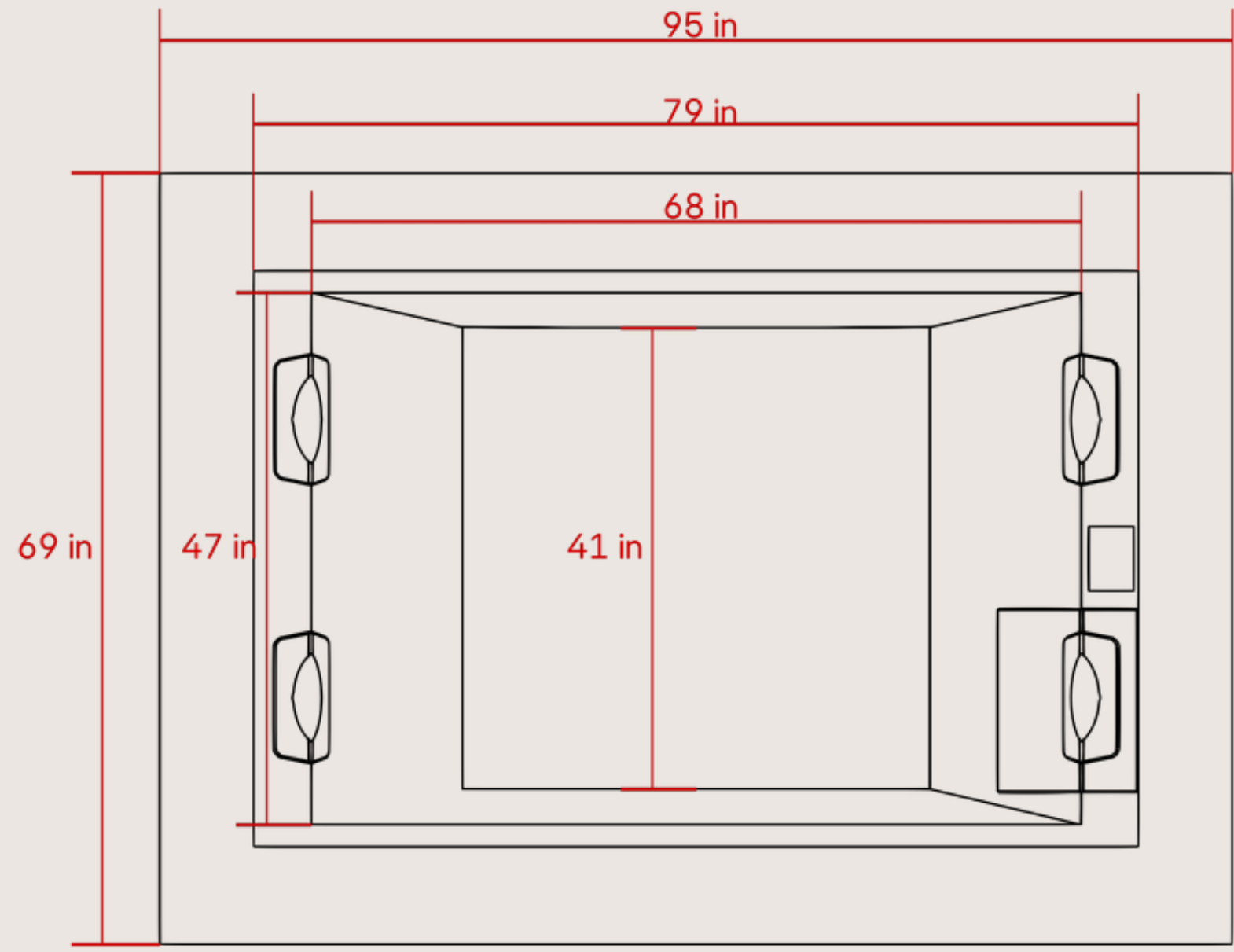



KEY FEATURES & BENEFITS

Ergonomic Seating Configuration

Full-body lounge seats with multiple hydrotherapy settings for the best experience.

Massage System

18 hydro jets and 24 micro jets deliver targeted relief from neck to calves.

Smart Control & Connectivity

Intuitive touch-panel operation with optional Wi-Fi Spa Control for remote scheduling and diagnostics.

Advanced Water Care

Premium UV treatment and ozonator keep water crystal-clear with minimal chemical use.

Thermal Efficiency

Special Insulation System and eco-efficient cabinet reduce heat loss by up to 25%, lowering operating costs.

Customizable Ambience

Color sense LED lighting package.





FINISHES & OPTIONS

Interior Cabinet

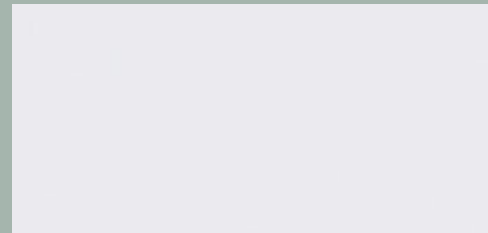

White

Solid Surface Cabinet

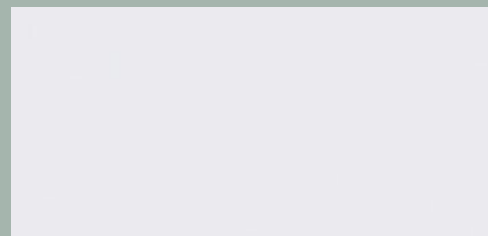

White



Dark Gray



Brown

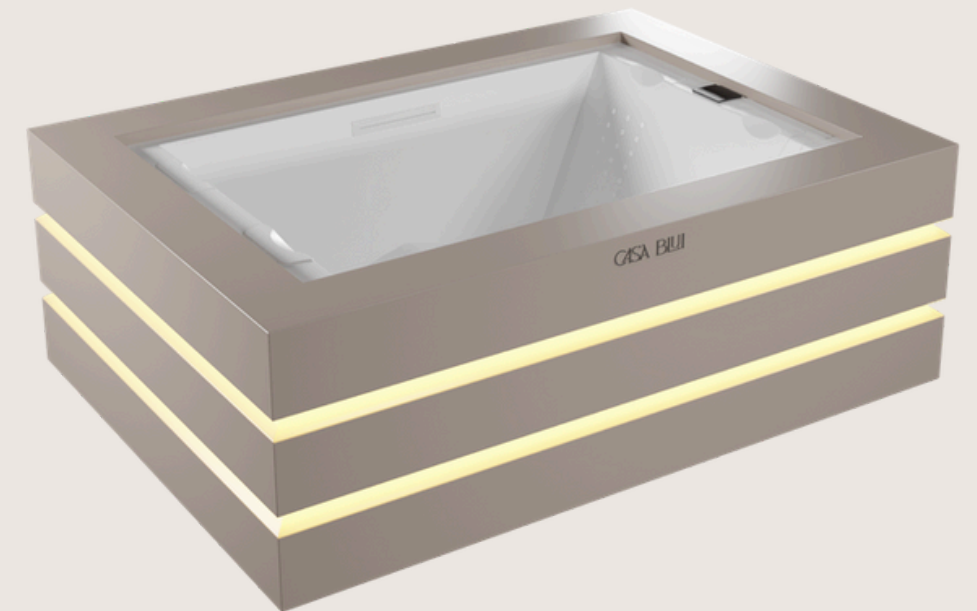
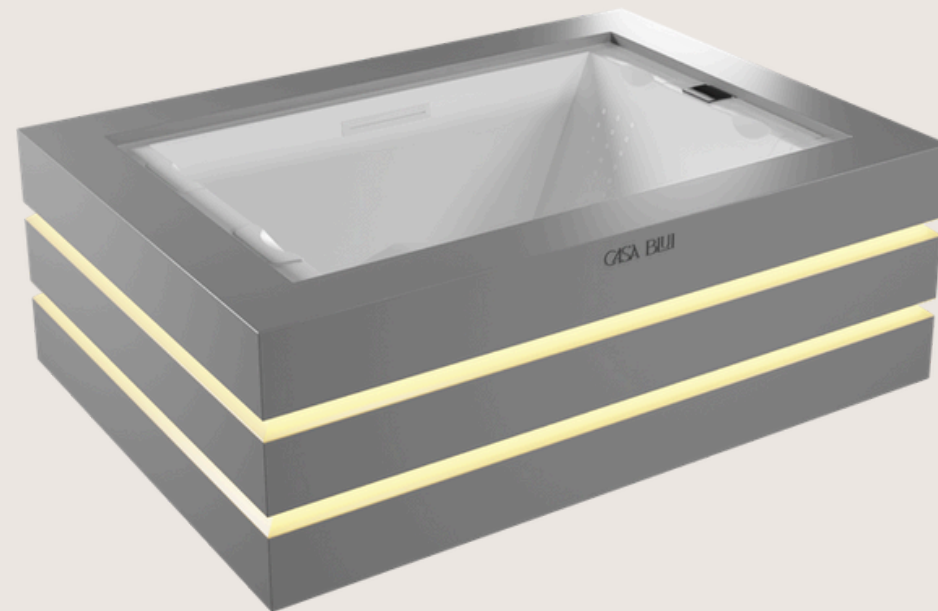
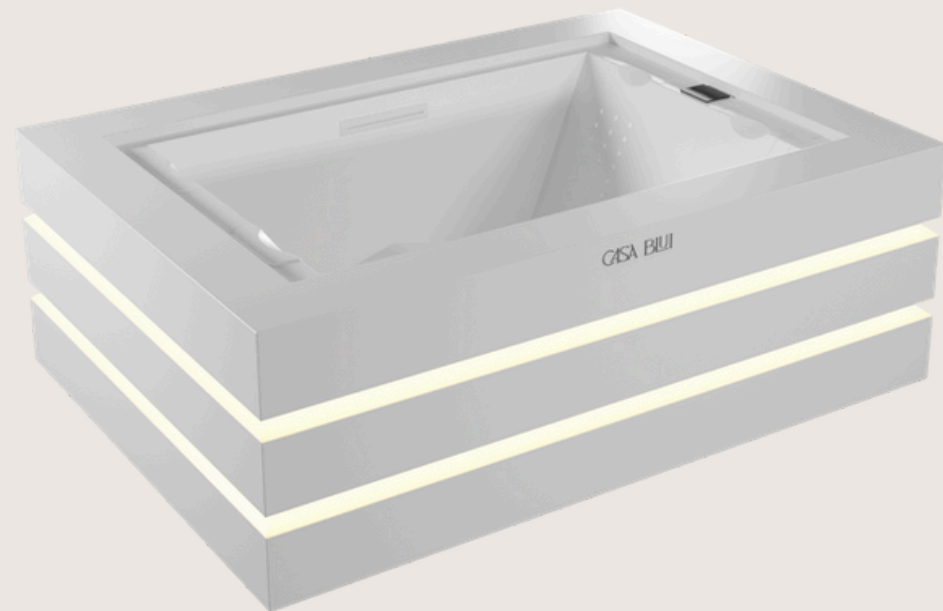



PRE INSTALLATION REQUIREMENTS

Delivery access & clearance

Ensure there's a clear path from the street/front door to the final spa location with at least ~15" extra clearance, and confirm if any special equipment (e.g., crane/forklift) is needed. This prevents last-minute logistics failures and damage during handling.

Structural foundation

The site must be level, structurally sound, and preferably a reinforced concrete pad ≥ 4 " thick (with rebar/wire mesh), proper slope for runoff ($\leq 1/2$ " over 8 ft), and free of hollows/bumps. It must be able to sustain 6000 lbs. This protects the shell and plumbing from torsion and uneven loading over time.

Service clearances

Maintain ~20" around all four sides; for built-ins, include removable panels for full service access. Adequate working room is essential for future maintenance, leak checks, and component replacement without demolition.

Electrical supply & protection

Provide a dedicated 220–240 V, 60 Hz single-phase circuit with a 50–60 A breaker per spec, copper conductors of the correct gauge, and clear access to the main breaker or GFCI disconnect. Proper power sizing and protection are critical for heater/pump performance and user safety.

Drainage & ventilation (built-in)

Onstall a 1.5" drainage hose for controlled emptying and at least two ~5.9" diameter vents to extract heat/moisture from the equipment bay. This prevents moisture accumulation, protects electronics, and aids thermal performance.



INSTALLATION REQUIREMENTS

Electrical safety & configuration

Verify a dedicated 50–60 A breaker, correct cable gauge for run length, secure F+N+T terminations, proper earth/ground, 230 V $\pm 10\%$ at the conduit, correct control-box DIP settings, and Group-2 output at 230 V. This prevents nuisance trips, under-voltage heating issues, and safety hazards.

Load & serviceability of the installation

Confirm the spa is level on a surface designed to bear full operating weight, maintain ~20" service clearance on all sides, and provide drainage for splash/leak water. This protects the shell/plumbing from stress and ensures future maintenance access.

Hydraulic integrity

Open and lock all gate valves and inspect thoroughly for leaks under/inside the cabinet. Catching leaks now avoids damage to electrics, framing, and finishes.

Water chemistry baseline

Fill from the top (or through the filter), set pH to 7.2–7.6, and ensure disinfectant is in range (Cl: 0.5–1.5 ppm; Br: 2.2–3.3 ppm). Proper start-up chemistry protects surfaces, seals, and bathers, and stabilizes commissioning.

Functional verification under load

Check jets (all open, strong flow), venturi valves, control panel (no errors), circulation pump, jet pumps, blower, lights, and UV/ozone system. Confirm total draw (all loads on) does not exceed 50 A. This proves the system performs as specified before handover.



SPA STEPS

The step provides a stable and secure platform for easy entry and exit from the hot tub. Its durable construction ensures long-lasting performance and safe support. Designed with a simple, functional shape, it complements most hot tub styles.

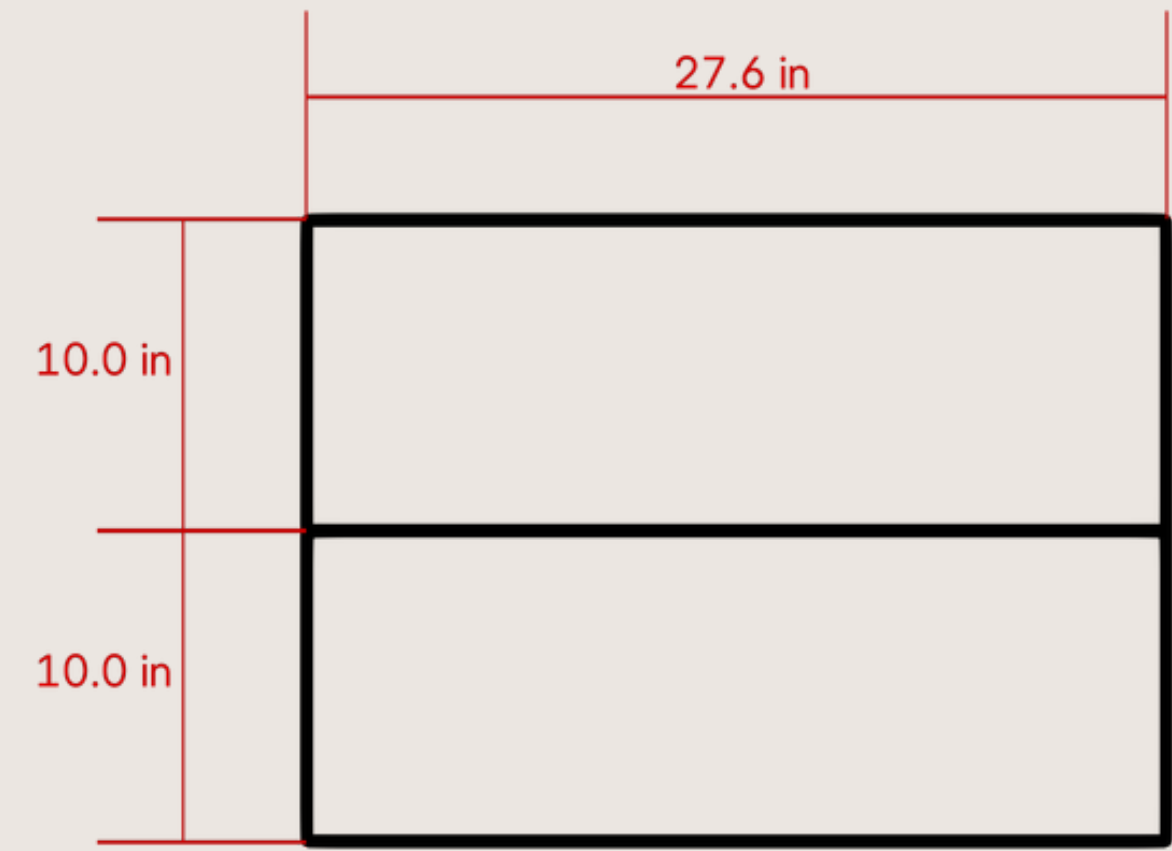

TOP VIEW

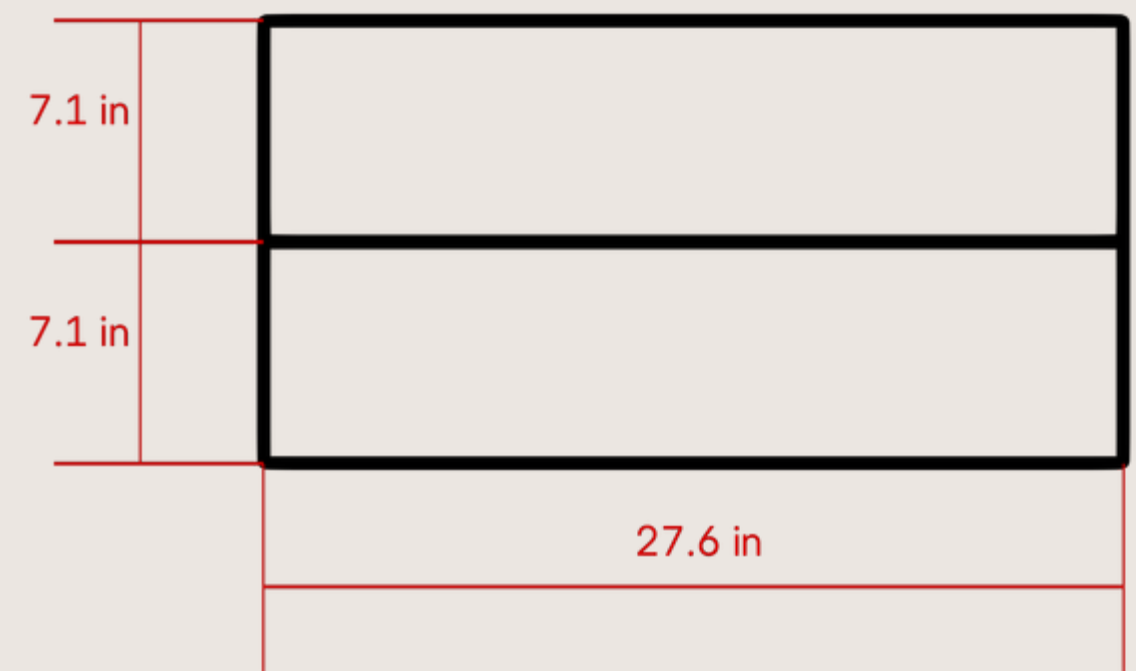

FRONT VIEW

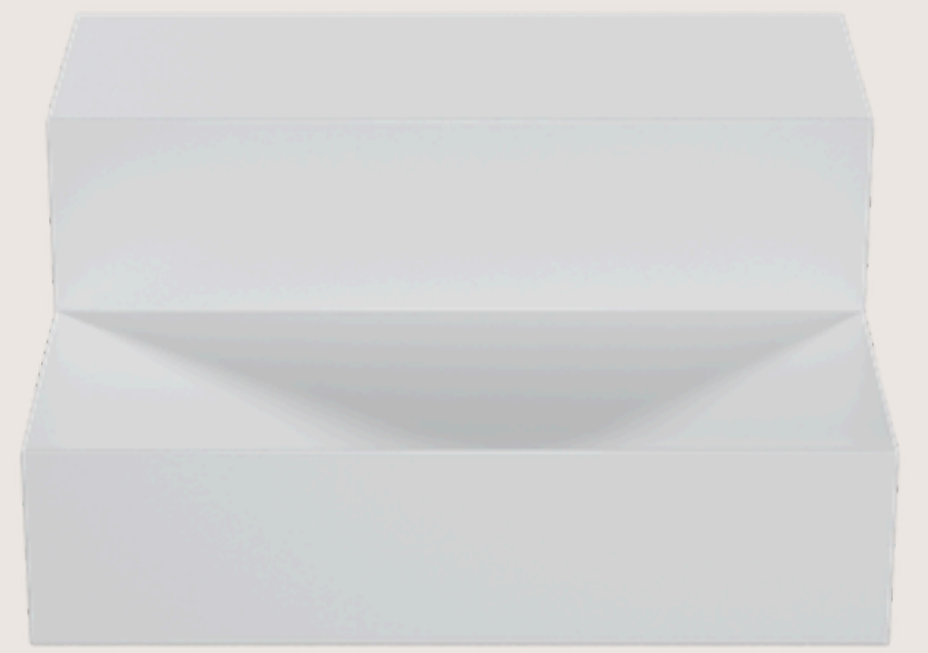



CASA BLUI PREMIUM COVER

The **Casa Blui Cover** is a premium, **three-piece, fully detachable** hot tub cover engineered for insulation, weather protection, and daily ease of use. Each of the three panels couples **magnetically**, so you can lift, remove, or re-arrange sections quickly, even in tight spaces.

Beneath the surface, a **tapered high-density EPS core** reduces heat loss, a heat-sealed vapor barrier protects the foam from moisture, and a galvanized steel C-channel adds rigidity.

A perimeter skirt, lockable tie-down straps, reinforced handles, rust-proof zippers, and weep holes round out a cover built for long service outdoors.

White exterior comes with **Gray Vinyl** and the gray ones come with **Gray Fabric** —both designed for heavy weather and easy cleaning.





WARRANTIES



15 Years for Frame



10 Years for Acrylic



2 Years for Components

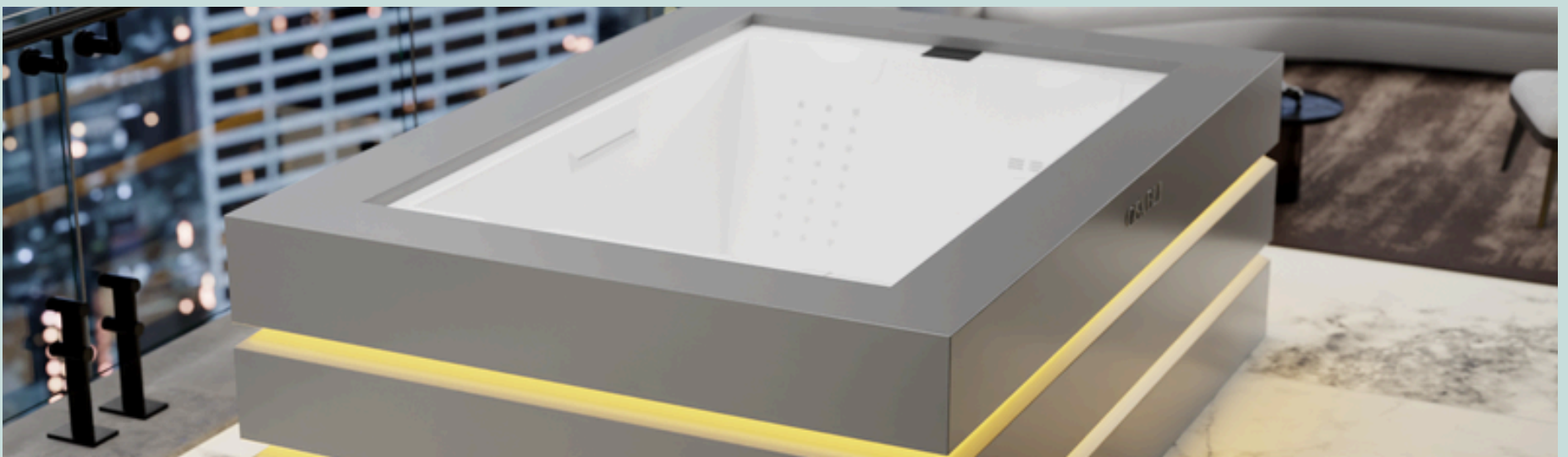
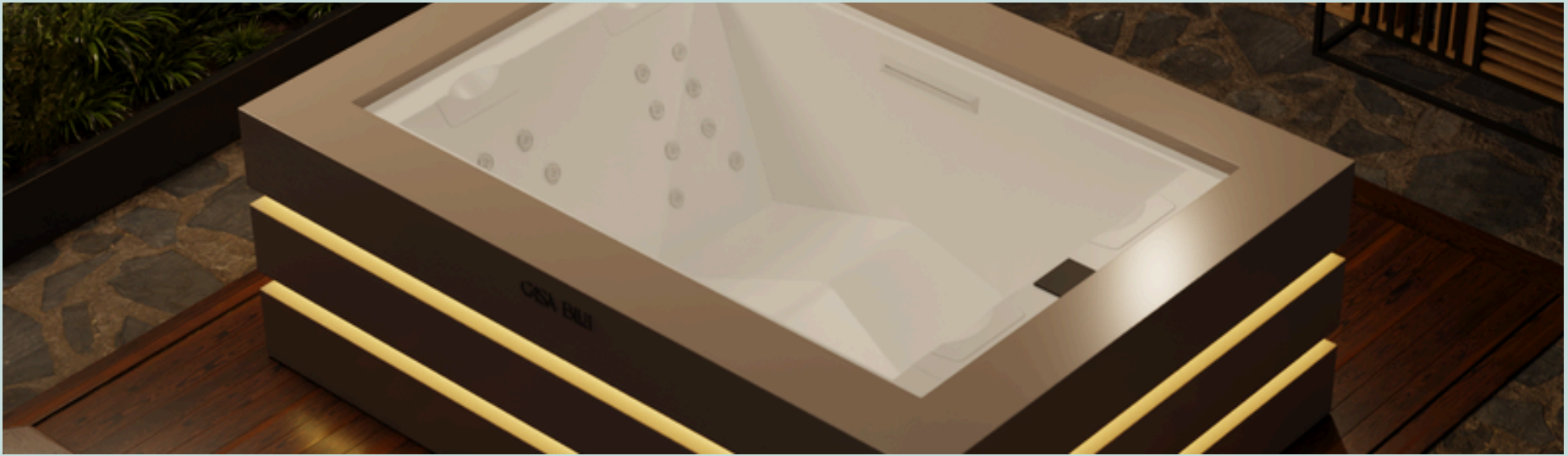
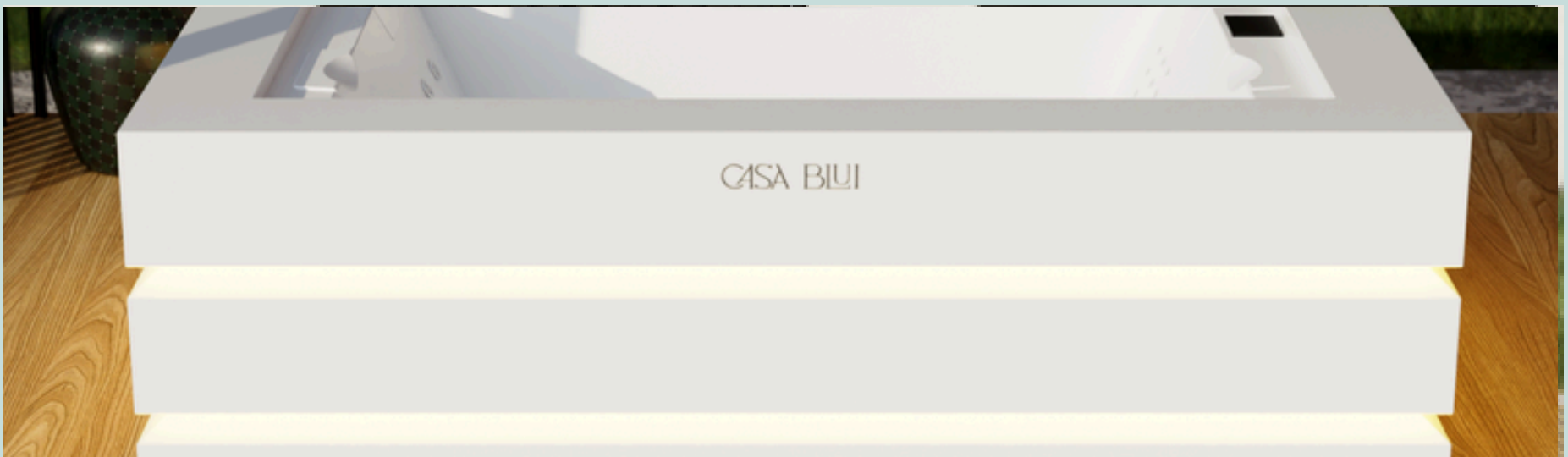



CONTACT & SUPPORT

Luis Acosta - Operations & Logistics department Head

 (305) 701-4085

 operations@casablui.com

Rodrigo Mirarchi - After Sales Department Head

 (310) 304-5872

 support@casablui.com

Marce Groenewald - Sales Department Head

 (305) 701-4029

 sales@casablui.com



CASA BLUI

Casa Blui
Operational Headquarters:
Miami, Florida, USA
Phone (+1) 305 701 4029
sales@casablui.com / www.casablui.com