



SPA
MANUAL

ONYX

CASA BLUI

MAIN SECTIONS INDEX

1	PRE-INSTALLATION	6
2	INSTALLATION	16
3	SPA INTERFACE USE	26
4	GENERAL MAINTENANCE	50

Proper preparation of the premises and systems will ensure a safe and rapid installation of the spa. For this reason we advise you to read this manual carefully and to carefully follow all the information contained herein.

⚠ WARNING

REDUCE THE RISK OF ELECTROCUTION

1. Never place an electric appliance within 5 feet of the spa.

REDUCE THE RISK OF CHILD DROWNING

1. Supervise children at all times.
2. Attach spa cover after each use.

REDUCE THE RISK OF OVERHEATING

1. Check with the doctor before to use if pregnant, diabetic, in poor health, or under medical care.
2. Exit immediately if uncomfortable, dizzy, or sleepy. Spa heat can cause hypertermia and unconsciousness.
3. Spa heat in conjunction with alcohol, drugs, or medication can cause unconsciousness.

WHEN PREGNANT, soaking in hot water for long periods can harm your fetus. Measure water temperature before entering.

1. Do not enter spa if water is hotter than 100° F (38° C).
2. Do not stay in spa for longer than 10 minutes.





SAFETY RISKS

- Risk of drowning. Children must never use the spa without constant adult supervision.
- Risk of entrapment and serious injury. Do not use the spa if any suction guard, suction fitting, or drain cover is missing, damaged, loose, or improperly installed.
- Risk of injury. Never replace a suction fitting with one rated below the original specified flow rate.
- Risk of electric shock. Do not allow electrical appliances or devices within 5 ft (1.5 m) of the spa.

! WARNINGS

- Read and follow all instructions before installation, operation, or maintenance.
- Installation, electrical connection, grounding, and bonding must be carried out by qualified personnel in accordance with all applicable local and national regulations.
- Users with reduced physical, sensory, cognitive capabilities, or without adequate experience, may only use the spa under proper supervision.
- Water temperature must never exceed 104°F (40°C).
- Before entering the spa, verify the actual water temperature with an accurate thermometer, since control systems may vary.
- Lower water temperatures are recommended for young children, for prolonged use, and for users who are alone.
- Pregnant or possibly pregnant women must consult a physician before using the spa and should not use water above 100°F (38°C).
- The use of alcohol, drugs, or medication before or during spa use may lead to unconsciousness, drowning, or fatal hyperthermia.
- Persons using medication, or persons with obesity, heart disease, high or low blood pressure, circulatory disorders, diabetes, clotting disorders, or similar medical conditions, must consult a physician before using the spa.
- Persons with infectious, skin, or contagious diseases must not use the spa.
- Do not use the spa immediately after strenuous exercise.

- Risk of electric shock. The spa must be properly grounded and bonded, including all required nearby metal components, in accordance with applicable electrical codes.
- Risk of electric shock. Disconnect power immediately if an electrical fault is detected, and do not restore power until the fault has been identified and corrected.
- Risk of serious injury or death. Do not dive into the spa.
- Risk of serious injury or death. Spa steps can be slippery when wet.

- Exercise caution when entering or leaving the spa.
- Do not place your head under water.
- Do not ingest spa water.
- Prolonged immersion in hot water can be hazardous to health.
- Hyperthermia may occur when the body temperature rises above normal. Its effects may include dizziness, drowsiness, lethargy, fainting, impaired judgment, inability to recognize heat, inability to leave the spa, fetal damage during pregnancy, and risk of drowning.
- If the product is equipped with a GFCI, it must be tested before each use according to the manufacturer's instructions.
- Unauthorized modifications, tampering, misuse, or maintenance not performed as instructed may cause injury, death, equipment damage, and void the warranty.
- During installation and maintenance, keep unauthorized persons away from the work area.
- Before performing any maintenance, disconnect the electrical and water supply.
- Cleaning and disinfecting chemicals must be kept tightly closed, properly labeled, and stored out of reach of children and pets.

**CAUTION: MAINTENANCE SUBSTANCES**

- Maintain water chemistry in accordance with the manufacturer's instructions.
- Perform regular maintenance to ensure safe, hygienic, and reliable spa operation.
- Use appropriate personal protective equipment during installation, maintenance, and chemical handling.
- Use only products and chemicals specified or approved by the manufacturer.
- Clean the filter regularly and, where applicable, drain, clean, and dry associated components whenever the spa is emptied.
- Do not place objects inside the spa during installation or maintenance, as they may fall into the system or damage components.
- When not in use, keep the spa covered if a cover is provided.
- The cover is not load-bearing. Do not walk, sit, jump, or place objects on it.
- Store chemicals in a cool, dry place away from heat sources.
- Dispose of packaging materials in accordance with local regulations and keep them away from children and animals.

NOTICE

- **Use only products and chemicals specified or approved by the manufacturer**
- **Contact the manufacturer if any instruction is unclear.**
- **Keep this manual for future consultation.**

**WARRANTY**

The manufacturer *cannot be held responsible and voids warranty* in the case of:

- Installations or connections that are not compliant or that are carried out without following the national regulations concerning civil and industrial installations.
- Pre-installation and installation carried out by unqualified personnel or otherwise not in compliance with the instructions in the pre-installation and installation requirements of the product;
- Incorrect preparation of the installation environment, including load-bearing surfaces;
- Accidents and damage due to a non-compliant installation or use of the bathtub;
- Masonry works that prevent the removal and handling of the spa or defective parts thereof.
- Product installations for which an according compliance checklist has not been submitted by the installer.
- The installer, acting on behalf of the seller or user, does not conduct an appropriate inspection of the Product's condition before installation. The warranty will not be valid if the Product is installed without this inspection.
- The installer, acting on behalf of the seller or user, does not ensure a correct spa (and all of its components) operation once installed, in order to confirm proper installation and water-hardness. The warranty will not be valid if this verification is not carried out.
- the Product being inspected, repaired, maintained, or handled by an unauthorized person without the manufacturer's knowledge & previous approval.
- All damage to the product resulting of unusual or extraordinary weather conditions or climatic events are not covered by warranty.

PRE-INSTALLATION

1	MEASUREMENTS AND TECH SPECS	7
2	IDENTIFICATION OF THE INSTALLATION SITE	10
3	PREPARATION OF THE INSTALLATION SITE	11
4	WATER SUPPLY	13
5	ELECTRICAL PREPARATIONS	14

1 MEASUREMENTS AND TECHNICAL SPECIFICATIONS

TECHNICAL DRAWINGS

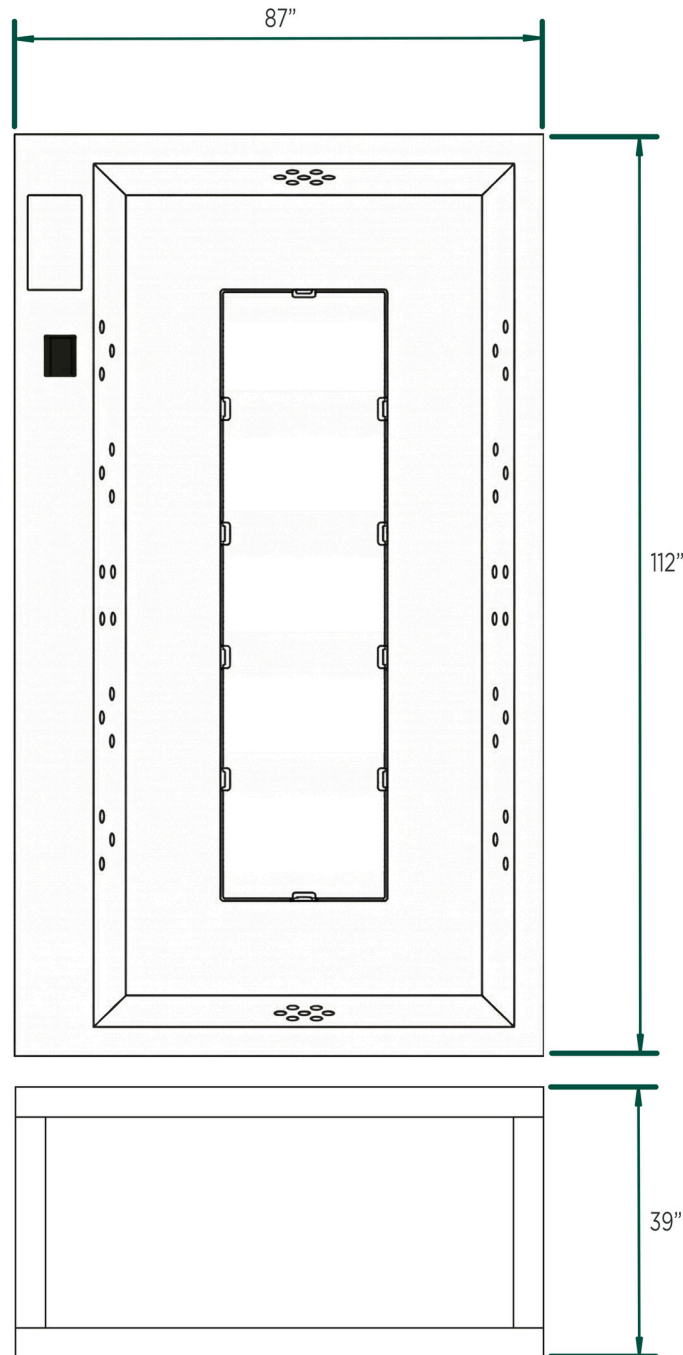
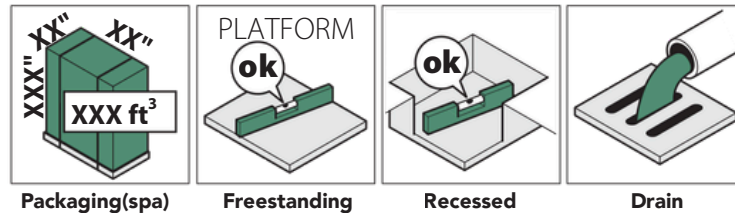

The manufacturer reserves the right to make improvements to the equipment at any time, without prior notice. Partial reproduction without the manufacturer's consent is prohibited. Measurements are purely indicative and not binding.

TECHNICAL SPECIFICATIONS

CAPACITY:	
TOTAL SEATS:	12 seats
TOTAL JETS:	56 jets
DIMENSIONS:	155" x 87" x 39"
WATER CAPACITY:	3930 L
DRY WEIGHT:	22650 lb
FILLED WEIGHT:	14600 lb
HEATING POWER:	11 kW
ELECTRICAL:	240V - 70A
FILTER TYPE:	Cartridge
PUMPS:	3 HP
CIRC PUMP:	0.5 HP
DISPLAY:	Spa touch 4 + WiFi

IMPORTANCE & INSTALLER PROFILE

The spa works efficiently and safely if it is installed correctly and in compliance with the regulations in force in the country of use.

This pre-installation guide provides information for a proper preparation of the environment, plumbing and electrical connections. This allows for a quick and safe installation.

The pre-installation stages involve the following professionals:

- A civil engineer for the calculation of the loading capacity of the platforms or floors;
- A qualified and certified company that will prepare the installation site according to the instructions provided in this guide, following current work safety regulations;
- Certified and qualified electrician who prepares electrical systems in compliance with local and national regulations regarding civil and industrial systems;

The user must promptly notify the professionals of any existing underground obstacles like gas, water, electrical or telephone lines.

Upon completion of pre-installation all specialists must issue a **procedure compliance checklist** of the systems installed. Without such document, the Manufacturer declines any responsibility for damage to the systems or premises where the spa is or will be installed.



We recommend checking with the appropriate state entities to see if there are constraints that prevent installation or if any form of permit is required.

An incorrect pre-installation could cause structural damage to the spa & its surroundings, resulting in warranty voidance.

TEMPORARY POSITIONING

The installation of the spa should be done immediately upon receipt. In any case, once unpacked, if it is necessary to temporarily place it on a surface awaiting the installation, it will be necessary to place level concrete slabs having a minimum thickness of 2 inches under the entire bottom of the spa.

Since the temporary base may shift, it is recommended to leave the spa in that position for the shortest possible time.

Do not leave the empty spa in DIRECT SUNLIGHT.

The surface temperature could rise above 176°F resulting in serious damage, including cavitation and the deformation of the surface and components.

Damage caused by direct exposure to sunlight is not covered by the warranty. In such conditions place a cover (fixed or mobile) to protect the spa.

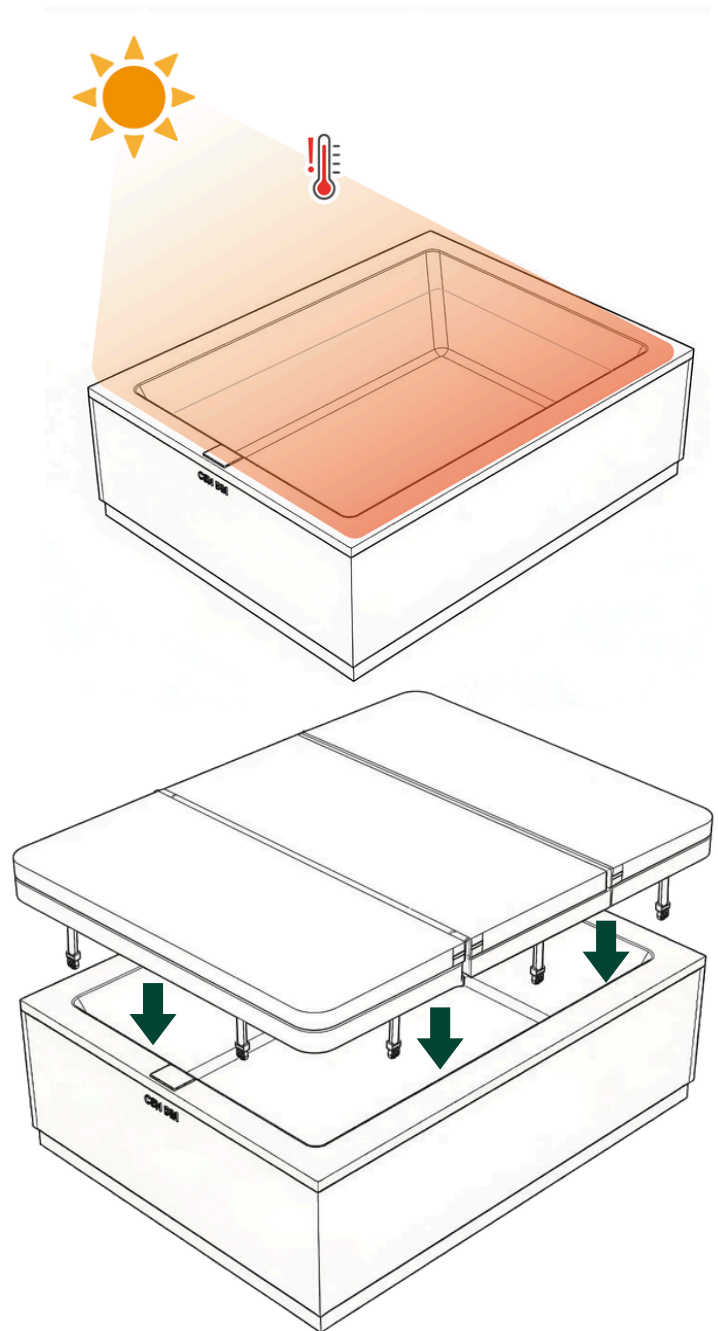

2 IDENTIFICATION OF THE INSTALLATION SITE



When choosing the position, take into account local regulations that prohibit any electrical installation (plug sockets, switches, lamps, etc.) in the area surrounding the spa for a distance of at least 23.6 inches and a height of 90.5 inches.



When choosing a location, bear in mind that the inspection side (front) must always remain accessible for future maintenance.

At least **20"** of clearance are needed **around the spa**.

The recommended **ambient temperature** for the spa must be **between 23°F and 113°F**, with a relative humidity of **20-80%**.

OUTDOOR INSTALLATION



Take into account the proximity of trees or hedges, and note that debris (e.g., leaves) can cause damage to the equipment over time that is not covered by warranty and make maintenance more expensive and frequent.

Also assess the best position to safeguard privacy and respect for others, as well as the best view or climatic position consistent with local regulations.



Consider the geological composition of the soil on which the supporting platform will be built.

Soils that are very sandy, permeable or subject to flooding could compromise the durability of the spa's support platform.

INDOOR INSTALLATION

Note that the evaporation of water in the spa in the presence of high internal temperatures can generate very high levels of humidity in the environment.

To overcome this drawback, choose an environment with good natural or forced ventilation. Humidity damage is not covered by the manufacturer warranty.



Take into account the size of the spa: narrow passages, doors and steps can be an obstacle to its transport to the desired place.

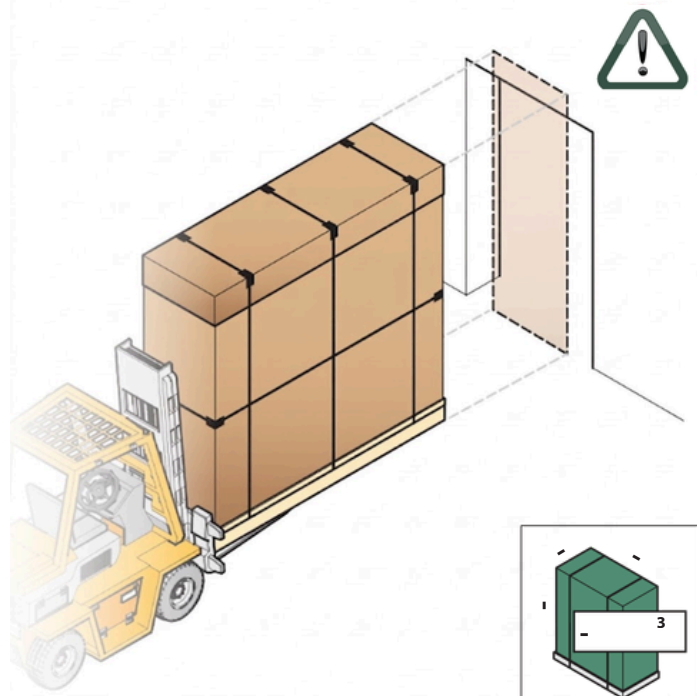
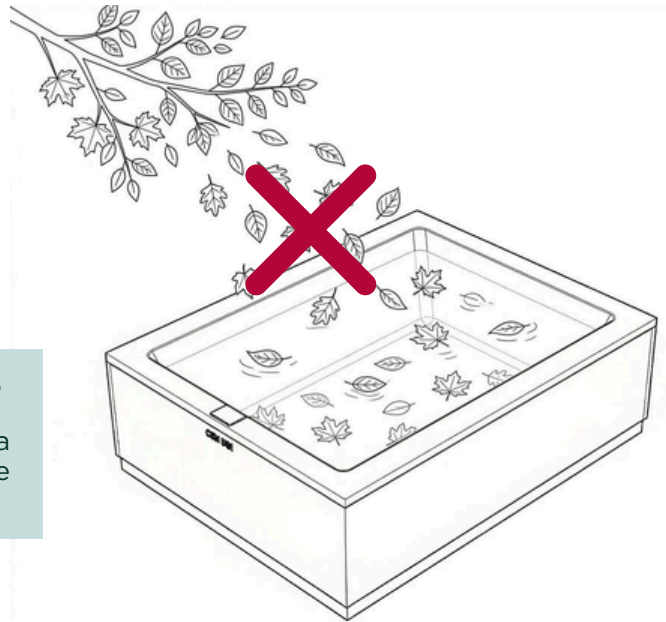

Packaging(spa)

3 PREPARATION OF THE INSTALLATION SITE



Before preparing the supporting surface, see the sections on the electrical connections for positioning the connections correctly.



Necessary installation features

- A drainage grating around the perimeter to help preserve the equipment and the structure (even for indoor installations).
- A non-slip flooring around the spa.

FREESTANDING INSTALLATIONS

As a base, build a platform or flooring in reinforced concrete, at least 4 inches thick, perfectly flat and suitable for supporting the weight of the spa and the people using it.

The manufacturer suggests a minimum load of 100 lb/ft². In any case contact a qualified construction engineer to calculate the appropriate load for the installation site.



Wedges or shims cannot be placed under the spa to level it. Remember to ground the structural reinforcement in accordance with electrical codes.

POSSIBLE CONCRETE PAD CONFIGURATIONS

1) Same as spa size

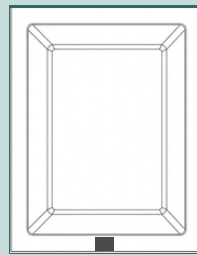

Clean & seamless

2) +20" front & back

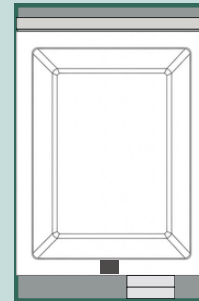

Sturdy support for accessories

2) +20" all sides

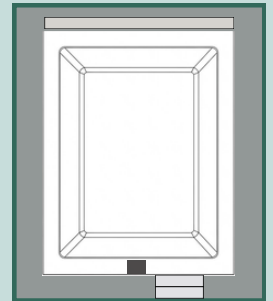

Symmetry & versatility

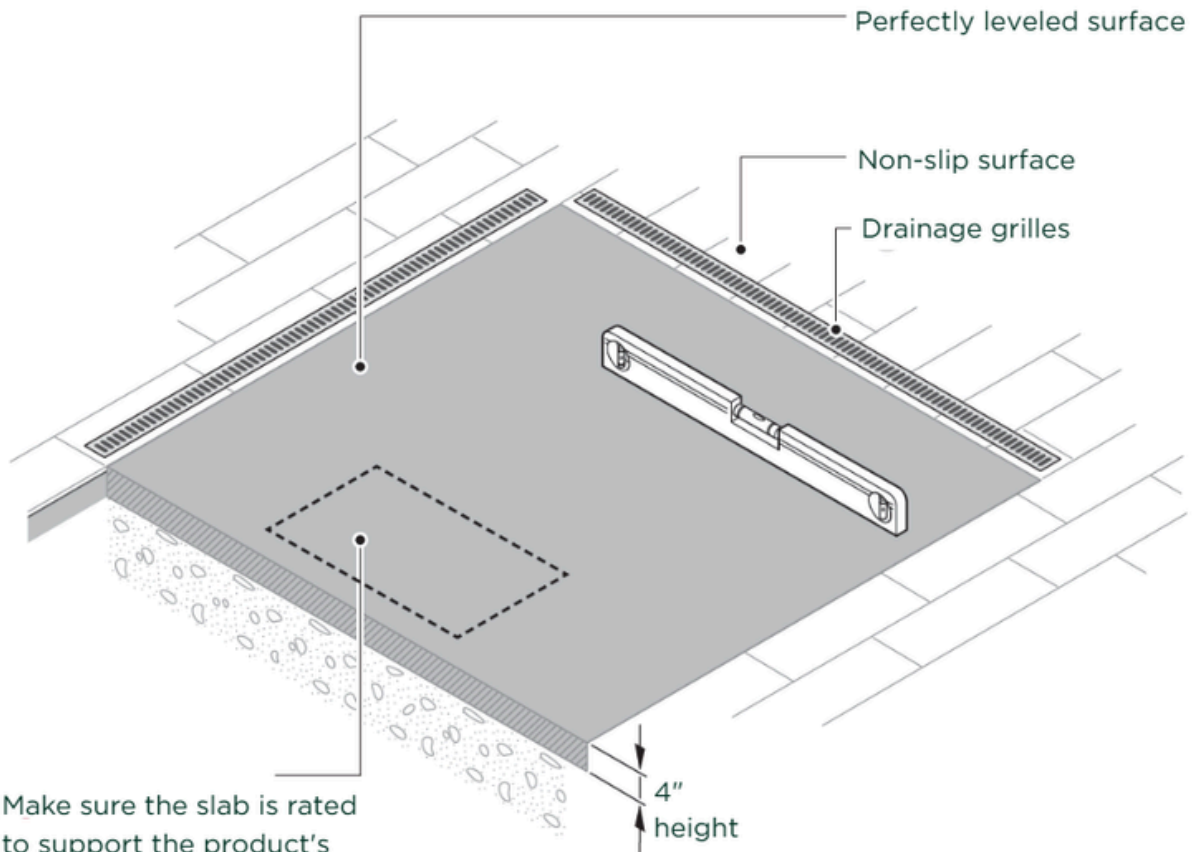

Make sure the slab is rated to support the product's **FILLED WEIGHT.**

BUILT-IN INSTALLATIONS

As a base, build a platform or flooring in reinforced concrete, at least 4 inches thick, perfectly flat and suitable for supporting the weight of the spa and the people using it.

The manufacturer suggests a minimum load of 100 lb/ft². In any case contact a qualified construction engineer to calculate the appropriate load for the installation site.



Wedges or shims cannot be placed under the spa to level it. Remember to ground the structural reinforcement in accordance with electrical codes.



Necessary installation features:

- **A** - A technical inspection port* at least 20" inches wide on all sides of the spa. This will make future maintenance or repairs easier.
- **B** - Drainage grating around the perimeter and in the recess to help preserve the equipment and the structure (even for indoor installations).
- **C** - A non-slip flooring around the spa.
- **D** - Two Ø6" vents **are advised** to ensure proper ventilation and extraction of the heat and moisture from the technical compartment. In case of self ventilating or non-airtight decks, this feature is not necessary.

To avoid damage due to freezing we recommend insulating the spa recess. This procedure prevents excessive condensation that over time cause odours and damage to all major internal components.

The choice of materials and thickness should be based on the minimum temperatures reached in the country of installation.

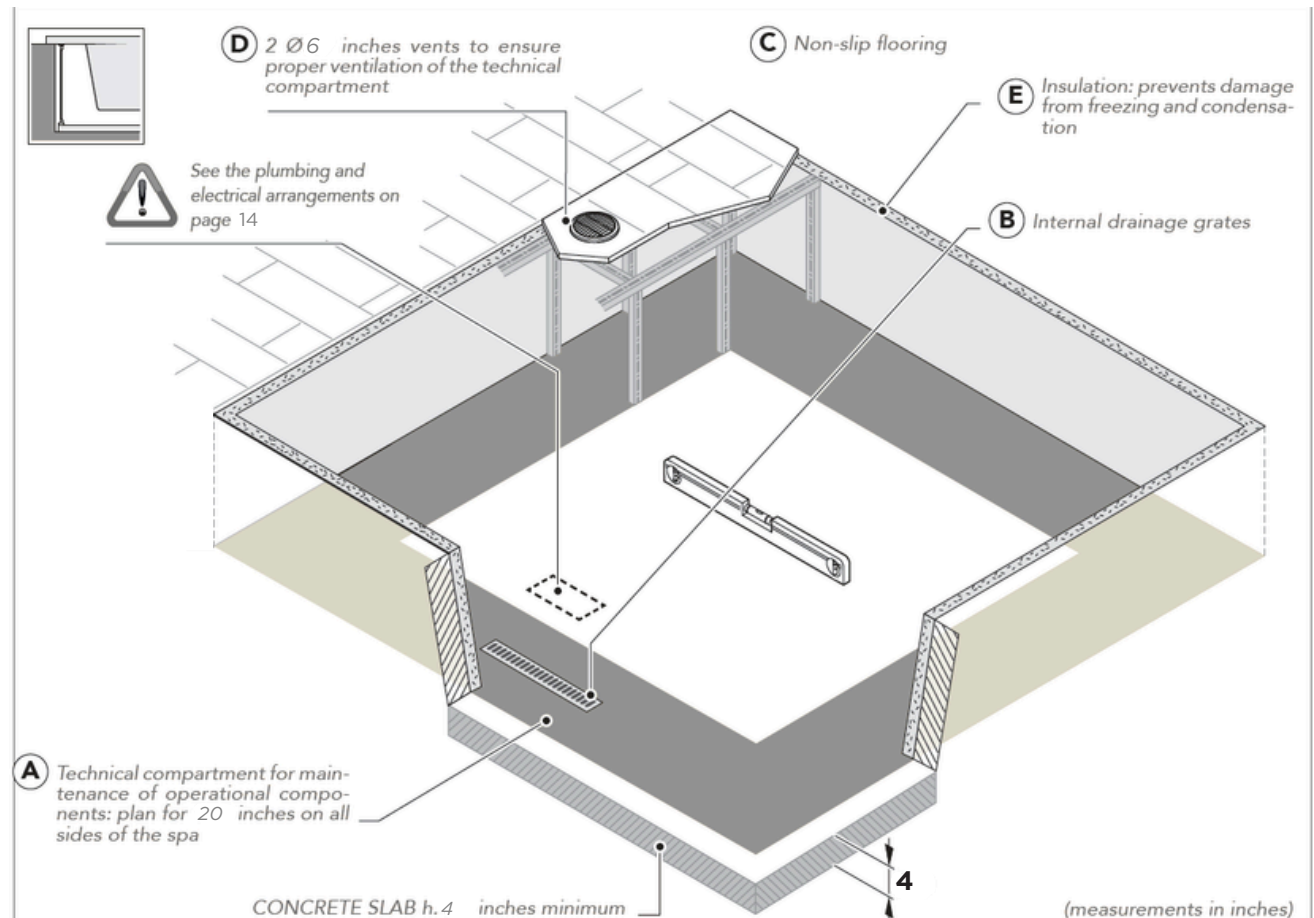

4

WATER SUPPLY

For optimal spa performance and low-maintenance water, keep pH, alkalinity, and hardness within the recommended ranges. Test these parameters regularly and adjust as needed to maintain proper balance.

- **pH:** Maintain between 7.4 and 7.6 for disinfectants to work effectively.
- **Alkalinity:** Keep between 80 - 125 ppm to stabilize pH and protect equipment.
- **Hardness:** Keep between 100 - 200 ppm.

Balanced water ensures it remains clear, clean, and easy to manage over time.

Water Source: Tap vs. Well

Maintaining clean, high-quality water is essential for both spa hygiene and long-term durability.

- Tap water is generally safe, as it is microbiologically treated and free from most metals, organic matter, and other impurities that could harm the spa.
- Well water, on the other hand, can contain oxides, dissolved metals, organic debris, and bacteria. These can encourage algae growth and lead to staining, scaling, or other damage to the spa's surfaces and components.

For best results, use treated tap water or properly filtered and disinfected well water before filling your spa.

Water Hardness

It reflects the total dissolved calcium in the water. It influences how corrosive or scale-forming the spa water is.

Very low hardness ("soft" water) is not recommended because it's aggressive to equipment and can stain the shell.

Very high hardness ("hard" water) promotes scale on surfaces and components.

If hardness is too high:

- Lower it by dilution—use a mix of roughly 75% hard water + 25% soft water as a starting point.
- If soft water isn't available, dose a stain/scale control product as directed on its label.

If hardness is too low:

- Avoid filling with soft water; raise hardness by topping up with a higher-calcium (harder) source.
- Once hardness is in range, it generally stays stable unless you add water that's much harder or softer.

Water Alkalinity

Alkalinity refers to the concentration of alkaline compounds (such as carbonates, bicarbonates, and hydrates) dissolved in the water.

When alkalinity drops below 80 mg/l or rises above 125 mg/l, pH can become unstable, making it harder to maintain proper water balance.

If below 80 mg/L, add an alkalinity increaser ; if above 125 mg/L, lower with small doses of pH decreaser or partially dilute with fresh water. Run the pumps to circulate, then retest. Be sure the products are compatible with hot tubs.

Water pH

It measures the level of hydrogen ions (H⁺) in the water, indicating its acidity or alkalinity. The recommended range is between 7.4 and 7.6 (neutral is 7). Maintaining this range helps:

- Protect bathers’ comfort — the skin, eyes, and mucous membranes are close to this natural pH level.
- Extend the lifespan of the spa’s surfaces and components.
- Ensure sanitizing chemicals work effectively, reducing overall product use.

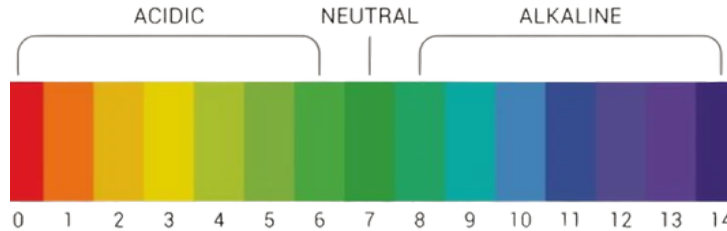

If below 7.4, add a **pH increaser** (Sodium Hydrogen Carbonate); if above 7.6, add a **pH decreaser** (Sodium Bisulfate). Run the pumps to circulate, then retest. Be sure the products are compatible with hot tubs.

Steps	Parameter	Ideal Range (ppm) – Minimum	Ideal Range (ppm) – Maximum	What Chemicals to Use — To Raise	What Chemicals to Use — To Lower
1	Total Alkalinity	80	125	Sodium Hydrogen Carbonate, or Sodium Bicarbonate	Sodium Bisulfate
2	Calcium Hardness	100	200	Calcium Hardness Increaser	Use a mixture of 75% hard water and 25% soft water or use a Stain and Scale Inhibitor
3	pH	7.4	7.6	Sodium Hydrogen Carbonate	Sodium Bisulfate

5 ELECTRICAL PREPARATIONS

The Casa Blui spas are built in compliance with UL laws and are tested during production to ensure the safety of the installer and user. The connection must be made by an experienced, qualified electrician.

a) READ AND FOLLOW ALL INSTRUCTIONS

b) A green coloured terminal or a terminal marked G, GR, Ground, Grounding, or the symbol* is located inside the supply terminal box or compartment. To reduce the risk of electric shock, this terminal must be connected to the grounding means provided in the electric supply service panel with a continuous copper wire equivalent in size to the circuit conductors supplying this equipment. * IEC 60417, Symbol 5019.

c) To be used, the spa requires a dedicated 240V, single-phase electrical connection protected by a 50A BREAKER. In the case your spa has an 11Kw heater, the breaker and wiring *MUST* be rated for 70A.

d)At least two lugs marked “BONDING LUGS” are provided on the external surface or on the inside of the supply terminal box or compartment. To reduce the risk of electric shock, connect the local common bonding grid in the area of the hot tub or spa to these terminals with an insulated or bare copper conductor not smaller than No. 6 AWG.

e) All field-installed metal components such as rails, ladders, drains, or other similar hardware within 3 m of the spa or hot tub shall be bonded to the equipment grounding bus with copper conductors not smaller than No. 6 AWG.

f) SAVE THESE INSTRUCTIONS.



The Manufacturer is not responsible for connections made in a way that does not comply with local codes, the specifications in this manual or tampering with any electrical component of the spa.



WARNING - This product is provided with a ground-fault circuit-interrupter.

The GFCI must be tested before each use. With the product operating, open the service door.

When the product stops operating, this merely indicates that the door is equipped with an electrical interlock. Next, push the test button on the GFCI and close the service door.

The product should not operate. Now open the service door, push the reset button on the GFCI and close the service door. The product should now operate normally. When the product fails to operate in this manner, there is a ground current flowing indicating the possibility of an electric shock.

Disconnect the power until the fault has been identified and corrected.



Local regulations prohibit any electrical installation (plug sockets, switches, lamps, etc.) in the area surrounding the spa for a distance of at least 23.6 inches and a height of 90.5 inches.

INSTALLATION

1	PRELIMINARY OPERATIONS	17
2	CHECKING SPA INTEGRITY	17
3	TRANSPORT AND POSITION	18
4	MAIN BOARD SETUP	19
5	FILLING THE SPA & COVER	21
6	STAINLESS STEEL - CABINET PANEL HANDLING	23

1 PRELIMINARY OPERATIONS

Before installing the spa, check that everything has been prepared.

Check that:

- A platform or a recess (in the case of recessed installations) of reinforced concrete, with a minimum thickness of 3.9-4 inches, has been placed, perfectly flat, leveled and suitable for supporting the weight of the spa and the people within.
- Ø6 inches vents have been installed to ensure proper ventilation of the technical compartment (in case of recessed spas).
- Drainage grating around the perimeter has been installed to help preserve the equipment and the structure (even for indoor installations);
- Non-slip flooring has been installed in the area around the spa
- For a recessed installation, a technical inspection port measuring at least 20 inches wide has been prepared on all sides of the spa;
- The connections to the electrical grid have been made in compliance with current regulations in force in the country/state of installation;
- A water softener has been installed for the water used to fill the spa if the water has a high degree of hardness;
- For outdoor recessed versions, the walls have been insulated to protect against the cold.

2 CHECKING SPA INTEGRITY

After having removed the spa from the packing, check its integrity.



Check:

- That there is no visible structural damage;
- That there are no cracks in the surface of the spa or in the outer covering (cracks due to incorrect transport or support are not covered by the warranty);
- The correct position of the sleeves and pipes;
- That all straps are correctly tightened.

If you notice any anomalies, do not proceed with the installation but rather promptly contact the Manufacturer.

More information

OUTDOOR INSTALLATION

Preparations

To run the electric cables from the main electrical panel to the spa underground ducts must be used and adequately protected against freezing by using proper insulation. It is also recommended to add drainage points in them to prevent standing water.

Choice of position: take into account the proximity of trees or hedges, and note that debris (e.g., leaves) can cause damage to the equipment over time that is not covered by warranty and make maintenance more expensive and frequent. It is also recommended to always install flooring around the spa, possibly anti-slip.

INDOOR INSTALLATION

Preparations

In the area used to access the spa it is recommended to install anti-slip flooring. The evaporation of water in the spa in the presence of high internal temperatures can generate very high levels of humidity in the environment. To avoid this problem, provide good natural or forced ventilation in the installation environment and, if necessary, a dehumidification system. Damage caused by this phenomenon is not covered by the manufacturer warranty.

Choice of position: Always take into account the size of the spa: narrow passages, doors and steps can be an obstacle to its transport to the desired place.

3 TRANSPORT AND POSITION

TRANSPORT

To move the spa to the place of installation a suitable lifting device (e.g., pallet jack) is required. If the installation is indoor, before moving the spa make sure that it can easily pass through the doors and hall- ways to reach the desired place of installation.

 Movement must be carried out using personal protective equipment (e.g., gloves, safety shoes, etc.) and taking all the necessary safety precautions for those involved and to not damage the spa.



During transport, lift the spa by holding it exclusively by the edge and NEVER by holding the plumbing lines or operational parts (e.g., pumps, etc.).

 During movement, the surrounding area must be kept free of persons not involved in the operation, animals or objects (e.g., packaging, etc.) that could get in the way.



APPROVED MOVING EQUIPMENT

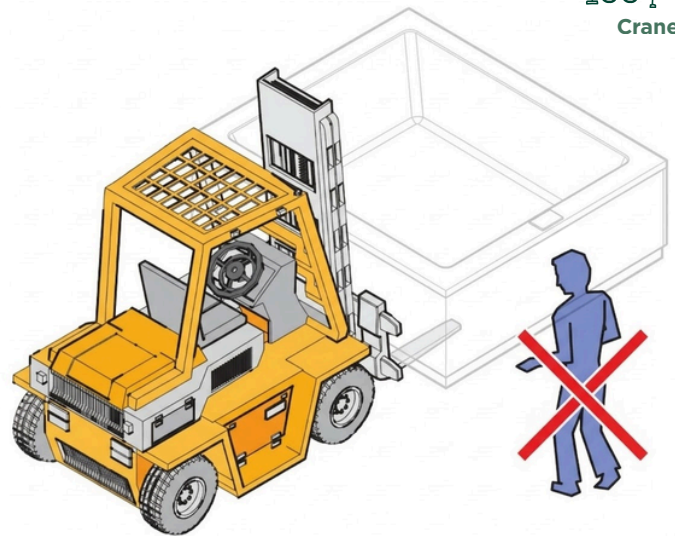
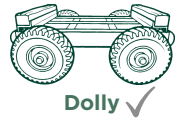

POSITIONING

TEMPORARY POSITIONING

Before installing and assembling the spa, ensure that the packaging is in perfect condition and contact us immediately if the packaging is damaged. If it is necessary to place the spa temporarily before installation, position it horizontally on a smooth, flat and level surface, and do not leave it empty and uncovered in direct sunlight

POSITIONING IN THE PLANNED LOCATION

In case of outdoor or indoor installation, position the Spa horizontally, placing the whole base of the unit on a smooth, flat and level surface capable of supporting the full operating weight, and ensure proper drainage and ventilation where applicable.

For an in-ground installation, the Spa structure must be fixed on the floor, with a trapdoor access for maintenance, no concrete covering, and 20" clearance around the spa. After positioning the Spa and filling it to the correct water level, connect the electrical equipment and proceed to commissioning only after confirming proper flow.

Do not expose the Spa to sunlight when it is empty and without a protection cover.

LOCATION	DEVICE	VOLTS	MAX AMPS	FROM	TO
J9	2-SP PUMP 1	240V	12A MAX	J46	GROUP 2
J14	1-SP PUMP 2	240V	12A MAX	J18	GROUP 2
	J14 LINE 1 CONNECTION			J43 J10	J19 J50
J15	SPA LIGHT	10V	2A*		
J21	CIRC PUMP	120V**	2A MAX	J20	GROUP 4
J32	OZONE		1A		
	CIRC AND OZONE LINE 1 CONNECTION			J81	J59
J33	AV ONLY	120V***	3A	J38	GROUP 4
J33	AV + CLIM8ZONE™ (C8Z)	240V***	2A + 8A	J38	GROUP 2
J44	HEATER	240V	5.5 kW		

* 2A LIMIT IS SHARED BY J15 SPA LIGHT AND CHROMAZONE™

** FOR 240V CIRC PUMP AND OZONE, CONNECT J20 TO GROUP 2

*** AV MUST BE REWIRED FROM 120V TO 240V WHEN USING CLIM8ZONE™ (C8Z) BY MOVING THE J38 WIRE FROM GROUP 4 TO GROUP 2.

SETUP #	CIRC PUMP	PUMP 1	PUMP 2	PUMP 3	BLOWER	TEMP SCALE
1	NONE	2-SPEED	2-SPEED	2-SPEED	NONE	°F
2	NONE	2-SPEED	2-SPEED	1-SPEED	NONE	°F
3	NONE	2-SPEED	2-SPEED	NONE	1-SPEED	°F
4	NONE	2-SPEED	2-SPEED	NONE	NONE	°F
5‡	NONE	2-SPEED	1-SPEED	1-SPEED	1-SPEED	°F
6	NONE	2-SPEED	1-SPEED	1-SPEED	NONE	°F
7	PROGRAMMABLE FILTRATION + POLLING	2-SPEED	2-SPEED	2-SPEED	NONE	°F
8	PROGRAMMABLE FILTRATION + POLLING	2-SPEED	2-SPEED	1-SPEED	NONE	°F
9	PROGRAMMABLE FILTRATION + POLLING	2-SPEED	2-SPEED	NONE	1-SPEED	°F
10	PROGRAMMABLE FILTRATION + POLLING	2-SPEED	2-SPEED	NONE	NONE	°F
11‡	PROGRAMMABLE FILTRATION + POLLING	2-SPEED	1-SPEED	1-SPEED	1-SPEED	°F
12‡	PROGRAMMABLE FILTRATION + POLLING	1-SPEED	1-SPEED	1-SPEED	1-SPEED	°F
13	PROGRAMMABLE FILTRATION + POLLING	2-SPEED	1-SPEED	1-SPEED	NONE	°F
14	PROGRAMMABLE FILTRATION + POLLING	1-SPEED	1-SPEED	1-SPEED	NONE	°F
15‡	NONE	2-SPEED	2-SPEED	1-SPEED	1-SPEED	°F
16‡	PROGRAMMABLE FILTRATION + POLLING	2-SPEED	2-SPEED	1-SPEED	1-SPEED	°F
17	PROGRAMMABLE FILTRATION + POLLING	1-SPEED	1-SPEED	NONE	1-SPEED	°F
18	NONE	2-SPEED	1-SPEED	NONE	1-SPEED	°F

SWITCHBANK S1 OFF

SWITCHBANK S1 ON

TEST MODE OFF	◀ A1	TEST MODE ON
DON'T ADD 1 HS PUMP W/HTR	A2 ▶	ADD 1 HS PUMP WITH HEAT
DON'T ADD 2 HS PUMPS W/HTR	◀ A3	ADD 2 HS PUMPS WITH HEAT
DON'T ADD 4 HS PUMPS W/HTR	◀ A4	ADD 4 HS PUMPS WITH HEAT
SPECIAL AMPERAGE RULE A	◀ A5	SPECIAL AMPERAGE RULE B
STORE SETTINGS**	◀ A6	MEMORY RESET**
1 MIN HTR COOLDOWN (ELEC)	◀ A7	5 MIN HTR COOLDOWN (GAS)
NOT ASSIGNED	◀ A8	NOT ASSIGNED
NOT ASSIGNED	◀ A9	NOT ASSIGNED
NOT ASSIGNED	◀ A10	NOT ASSIGNED

** SWITCH # 6 SHOULD BE SET TO OFF UPON FINAL INSTALLATION.



Before installation, please ensure that the preinstallation checklist is complete and signed by a qualified technician, and have the general maintenance manual available after installation

The installation must be carried out with the preinstallation checklist complete and signed by a qualified technician. All electrical work must be performed by a licensed/qualified electrician and comply with all applicable national and local electrical codes and inspection authority requirements. If there is any doubt about soil bearing capacity or floor load ratings, a qualified geotechnical or structural engineer must be engaged

5 FILLING THE SPA & COVER

Perform a preliminary cleaning of the spa using a soft cloth or non-scratch sponge with a little soap and warm water. If using a commercial cleaner, make sure it is specifically recommended for stainless steel surfaces and always spot-test it in an inconspicuous area first. Never use abrasive powders, steel wool, scouring pads, harsh polishing compounds, or corrosive chemicals such as bleach, muriatic acid, chloride-based cleaners, or similar products, as they may scratch, stain, or permanently damage the spa surface.

Before filling, once again check the quality of the water supply. This is very important for the well-being of the users and for the spa's durability.

For filling, use a rubber hose as shown in the figure. The water used must meet the requirements detailed in the previous pages and



Do not leave the Spa uncovered, empty, and exposed to direct sunlight.

Prolonged UV and heat can cause warping, discoloration, and surface damage to the Spa and its accessories, and damage caused by direct exposure to sunlight is not covered by the warranty. If the Spa must be drained, keep it shaded and covered, and refill it promptly. A UV-resistant protection cover is recommended to help protect the shell and equipment from sun damage and falling debris. A fitted thermal cover also helps retain warmth efficiently.

The cover is especially useful if the Spa is installed outdoors. In exposed areas, consider positioning the Spa near walls or privacy screens to reduce heat loss. Casa Blui cover options also include lockable tie-down straps designed for long outdoor service.

Manual filling with a garden hose

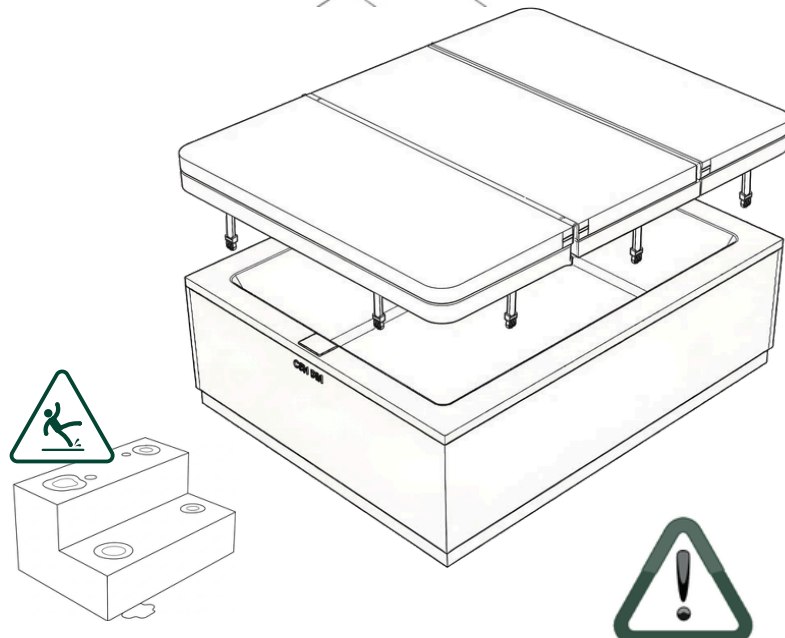
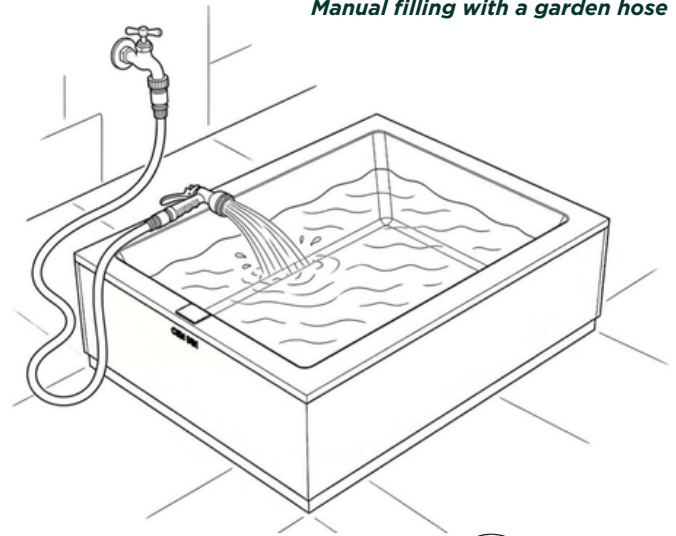

The spa steps **ARE NOT** rated as "Anti-slip". Commercially available *Non-slip & waterproof* adhesives can be applied **for extra grip**.

The spa cover **IS NOT** guaranteed to withstand **sustained unusually strong winds**. Any weather-related damage **is not covered by warranty**.

FILTER REPLACEMENT & CLEANING



Before cleaning the filter cartridge and, in any case, before any electrical or mechanical work, switch OFF power at the breaker and secure the system against restart (lock-out/tag-out where applicable).

Cleaning/replacing the filter cartridge depends on how often the spa is used. In general, rinse the cartridge with a gentle garden-hose stream every 1-2 weeks with heavy use or about monthly with lighter use to remove hair, lint, and fine debris. Be sure to clean well between the pleats so water reaches the inner folds of the filter. To remove embedded oils, soap film, and minerals, perform a chemical soak about once a month for heavy use or every 2-3 months for lighter use, and also at each drain/refill. In all cases, use a spa-specific filter cleaner according to the product label, rinse thoroughly, let the cartridge air-dry completely before reinstalling, and replace it earlier if it shows damage or persistently reduced flow.



The filter cartridge must be allowed to air-dry completely before reinstalling

EMPTYING THE SPA

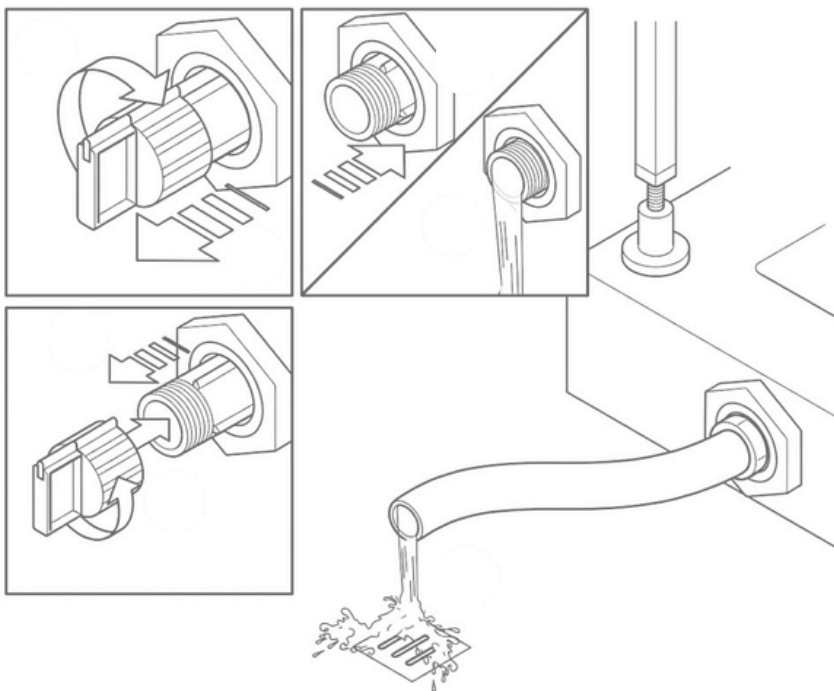

When emptying the Spa, the drainage valve should only be open while the Spa is being emptied and, before any electrical or mechanical work, switch OFF power at the breaker and secure the system against restart

Emptying takes place through the Spa's manual emptying system by gravity, through a drainage valve of 3/4". If it is necessary to refill the Spa, use a manual filling system with a garden hose or similar and fill the Spa through the top, with clean water, to the level indicated



Before draining the spa, test the sanitizer level and ensure it remains within the recommended range. If the level is above the range, circulate with the cover open to allow dissipation, or dilute with fresh water as necessary.

6 STAINLESS STEEL - CABINET PANEL HANDLING

PANEL PLACEMENT/REMOVAL

The panels are designed for straightforward installation and are secured to the spa structure using roller catch latches.

1. Secure suction cups

Attach the provided suction cups to the panel you need to remove, make sure both the panel & cups are clean & dry.



2. Un-latch panel

Pull the panel outwards in a firm but controlled manner, the panel is only latched from the top.

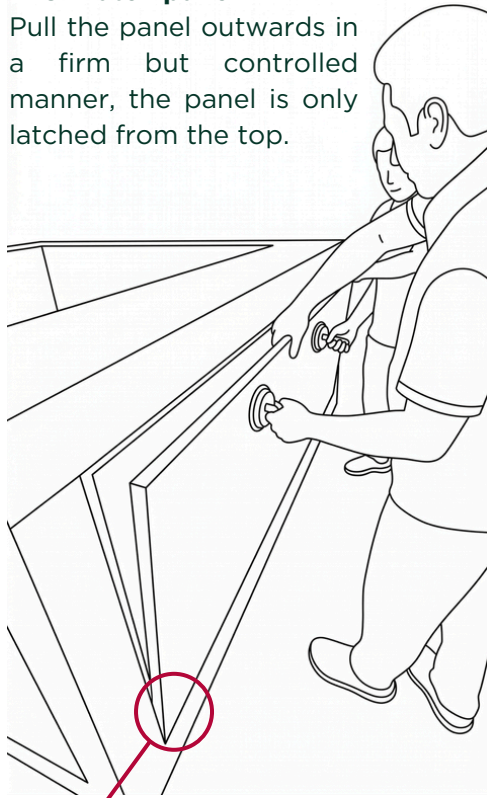

3. Move the panel to a safe location

Lift the panel from the top & move it to a safe place before any procedure begins.

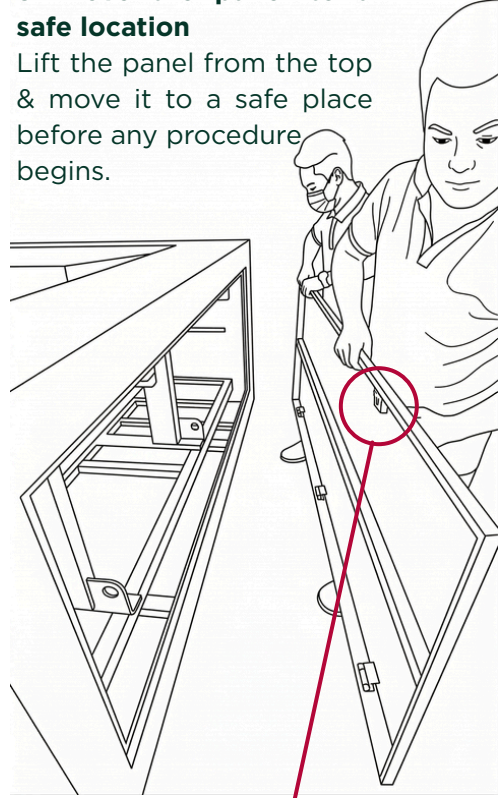

PANEL RESTING.

The panel's bottom rests on top of the panel frame's lip, by three "L" profiles that allow it to stay in place & pivot cleanly when removing the panel.

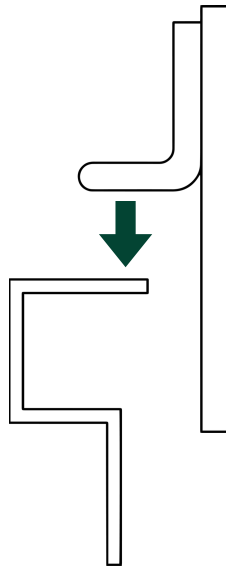

LATCH MECHANISM.

The chosen system for our stainless steel spas are heavy-duty roller catch latches, ensuring durability & reliability in all conditions.

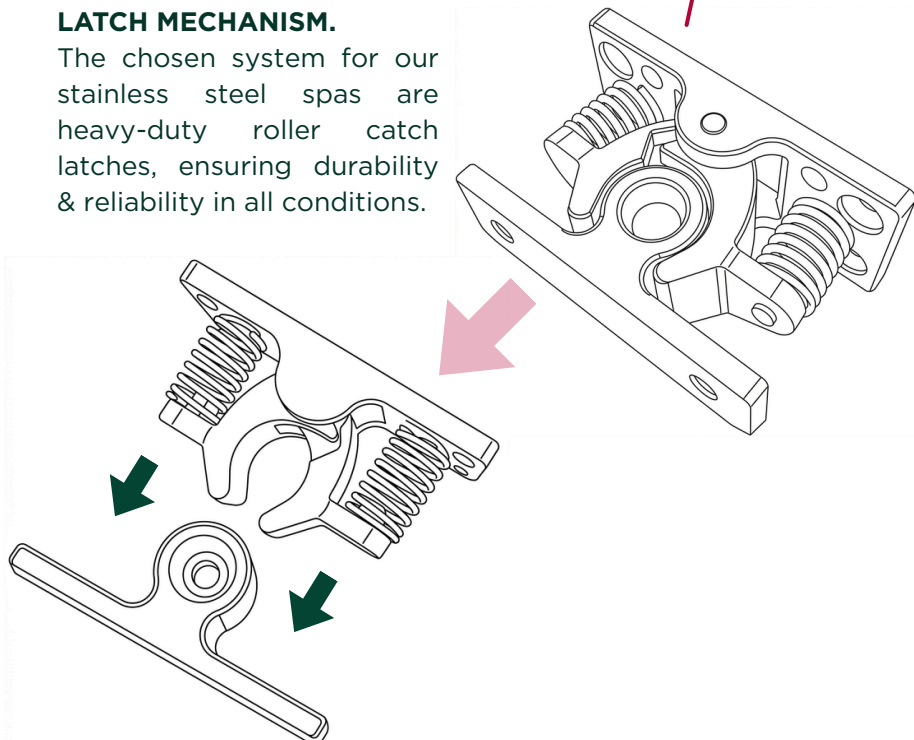

SPA INTERFACE USE

1	YOUR SPA TOUCH™ 4	25
2	REMINDERS, WARNINGS ERRORS	26
3	FEATURES AND FUNCTIONALITY	27
4	QUICK GLANCE SCREENS	28
5	PREPARE YOUR SPA	29
6	PRIME THE PUMP	30
7	CONNECT YOUR SPA TOUCH 4	31
8	SOFTWARE UPDATE	35
9	SET THE TIME	36
10	SET FILTER CYCLES	37
11	ADJUST WATER TEMPERATURE	39
12	START SPA HOLD	40
13	TURN ON THE JETS	41
14	ADJUST SCREEN BRIGHTNESS	42
15	HEAT MODE & TEMP RANGE	43
16	SET LOCKS	45
17	SET LANGUAGE	46
18	DIAGNOSTICS	47
19	SPA INFORMATION	47

1 YOUR SPA TOUCH™ 4

TOUCH TO START

Your Spa Touch 4 display by touching anywhere on the screen. Use your fingertip to touch, scroll, slide or swipe to activate the various icons and images on the panel screen.

NOTE: Features and functions available are shown here. Your system display may vary.

To "wake up" SpaTouch 4:

1. Touch the SpaTouch 4 Screen in Sleep Mode.
2. The Splash Screen displays, and then the Home Screen displays.

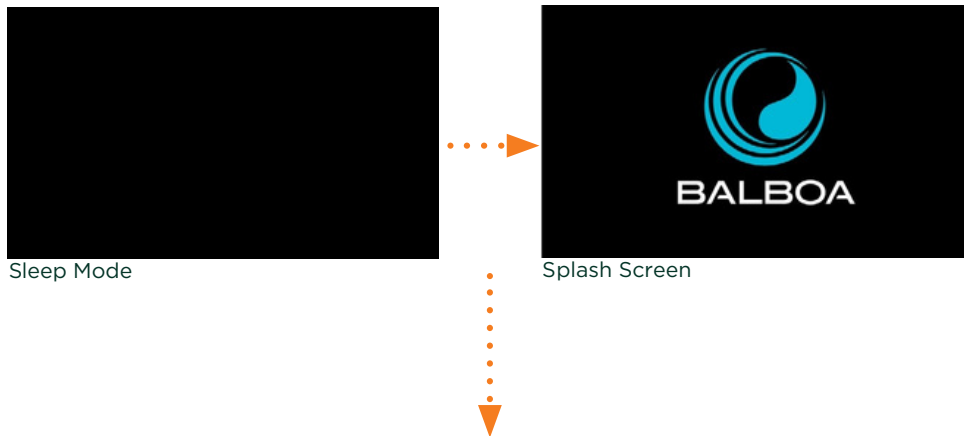

NAVIGATING HOME

The Spa Touch 4 Home Screen is your central connection to all your spa offers.

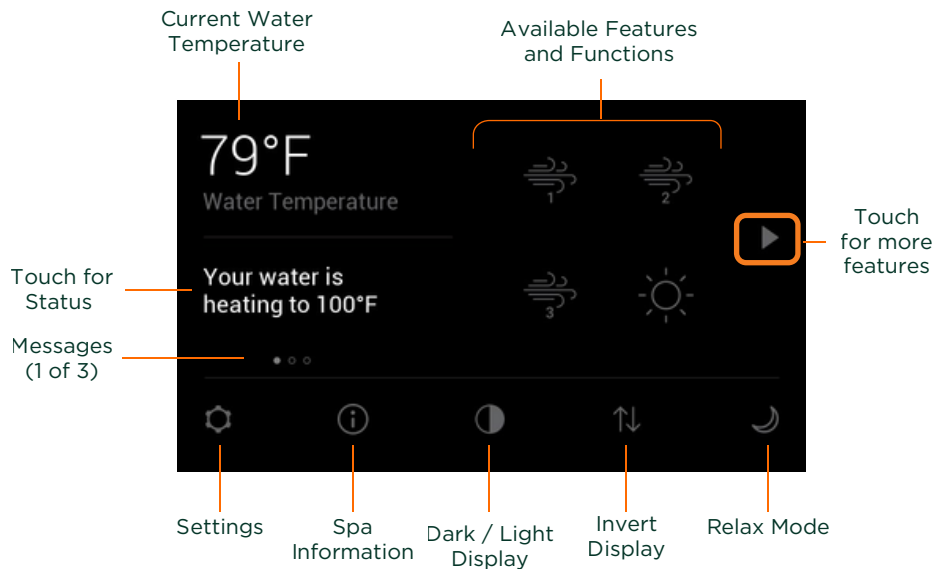

Touch the **arrows** ◀ ▶ to advance through your connected spa selections and the Home Screen.

The bottom row of functions are accessible when displayed for quick access.

2 REMINDERS, WARNINGS, ERRORS

NOTE: Features and functions available are shown here.

Your system display may vary.

Interactive messages display to alert you of status and changing conditions that affect your spa's maintenance or performance.

See your product manual for more information.

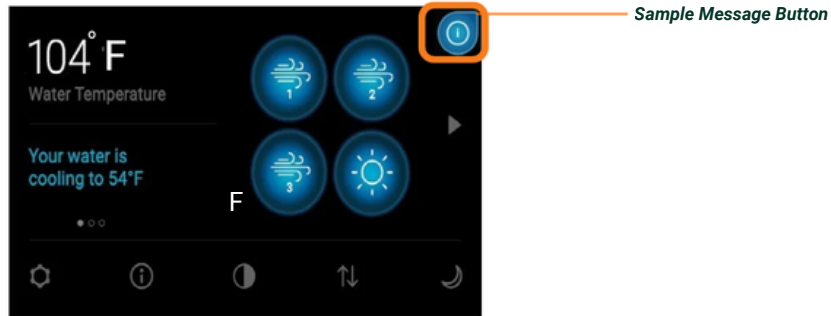

Message Buttons

Button	What it means	Example Messages
	Informational and Instructive messages.	"Clean the filter"
	Alert to possible damage to product or property if you fail to comply with the cautionary statements that accompany it.	"The pH is high." "Program memory failure."
	Warning, whether mechanical or system related, which may affect operation and requires immediate attention.	"Insufficient water flow detected 3 times while attempting to heat. Service needed."

Message Display Samples

Each message describes the purpose and steps to take, depending on the spa environment.

NOTE: Messages are interactive and when touched display more details.

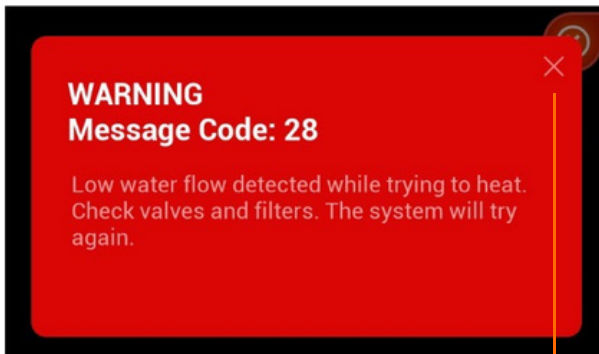

Touch to close

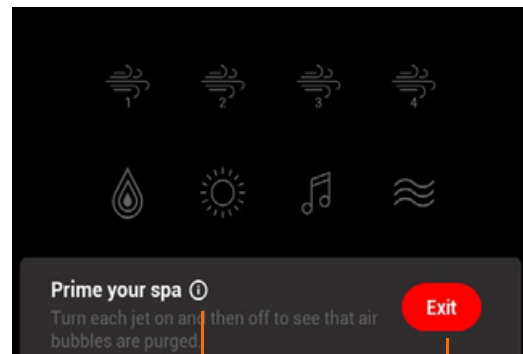

Touch for more details

Touch to close

3 FEATURES AND FUNCTIONALITY

NOTE: Features and functions available are shown here. Your system display may vary. Touch your available features repeatedly to activate on and off.

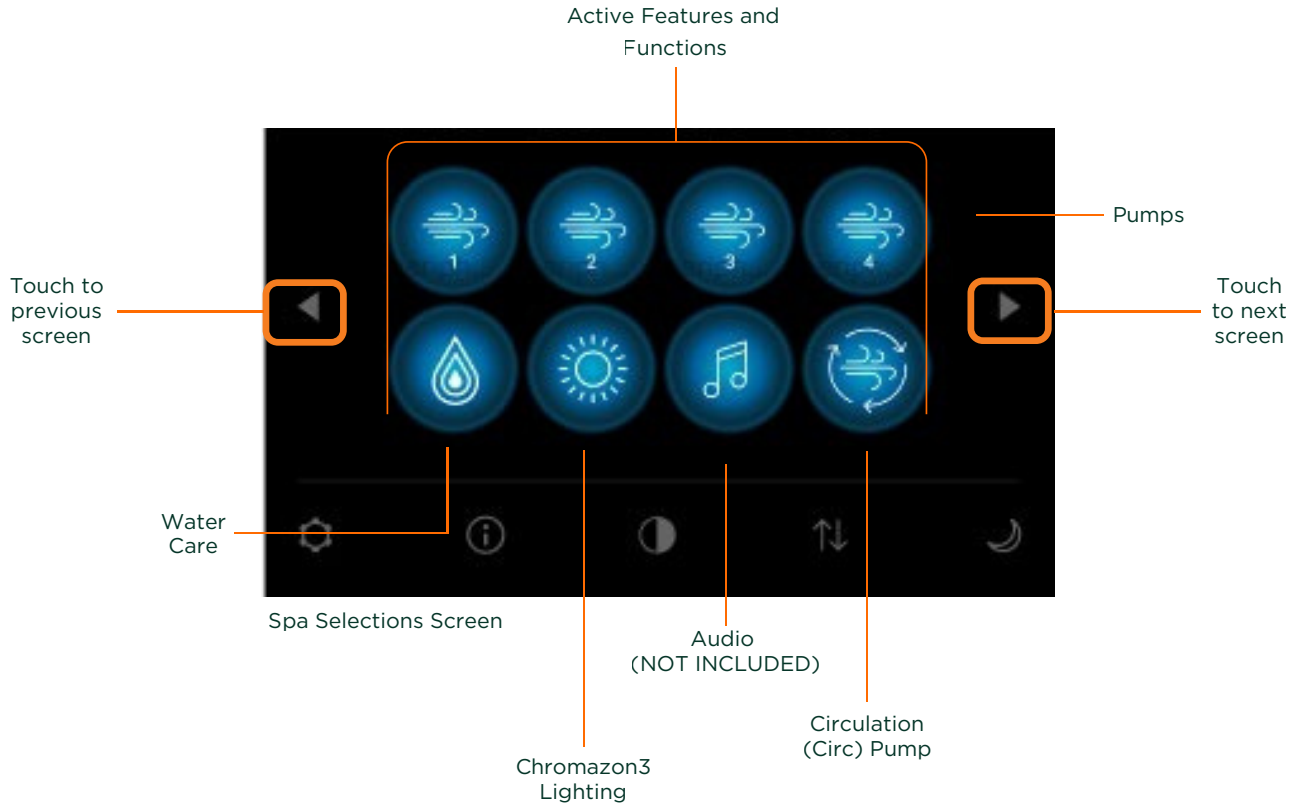

Where available, spa systems using multispeed pumps display these active indicators as you touch repeatedly.

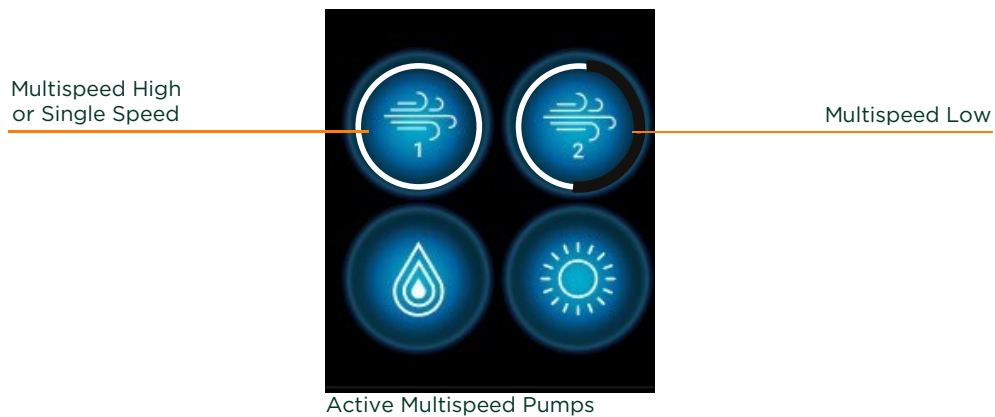

4 QUICK GLANCE SCREENS

NOTE: Features and functions available are shown here. Your system display may vary.

The Quick Glance Screen displays a simple time and current water temperature status.

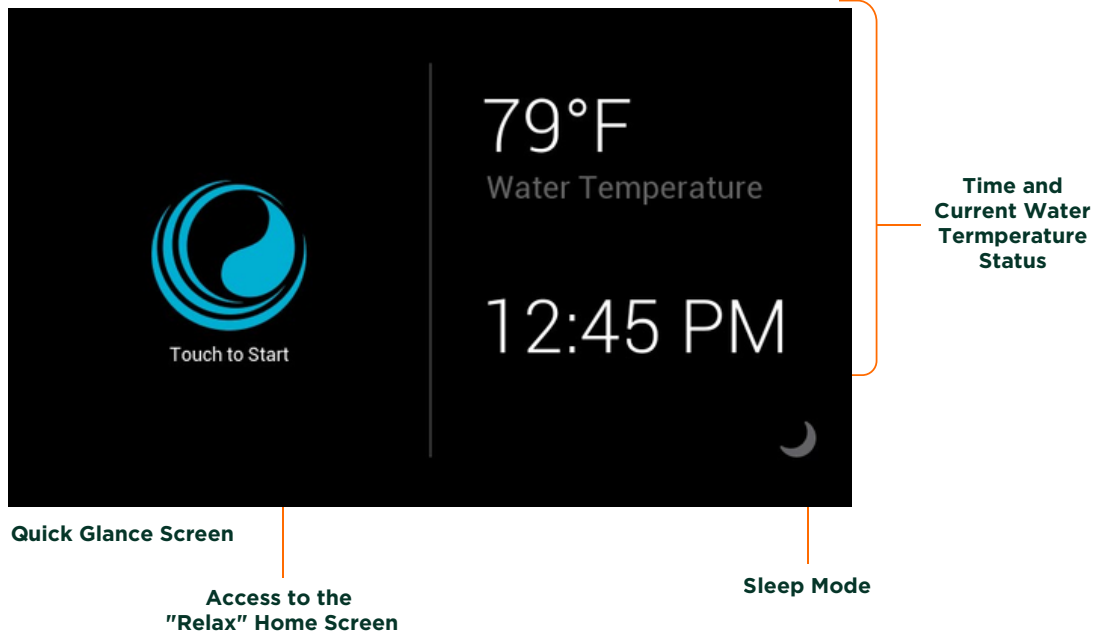

The Relax Screen displays, which also occurs after no screen interaction for an extended period of time.

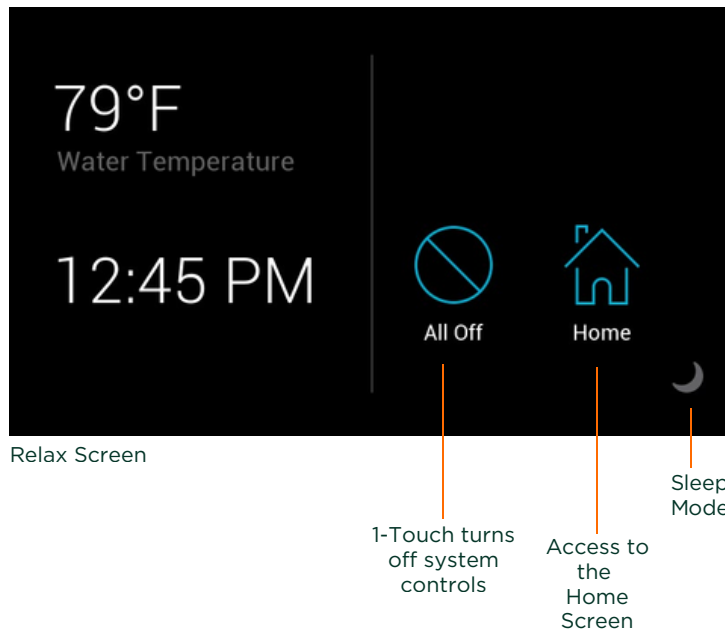

All Off* - 1-Touch control that turns off all currently active functionality, including the heater and pump, lights and music, where available.

To restart, touch "**Home**" to access the Spa Selection Screen and touch features and functions on.

* Circulation pump (Circ pump) remains on where available.

5 PREPARE YOUR SPA

NOTE: Features and functions available are shown here. Your system settings display may vary.

BEFORE YOU SOAK

IMPORTANT: Your spa requires essential settings to provide optimal performance.

Follow these steps to prepare your spa for first use:

1. "Prime The Pump" on **page 7**.
2. "Connect your Spa Touch 4" on **page 8**.
3. "Update Software" on **page 11**.
4. "Set The Time" on **page 12**.
5. "Set Filter Cycles" on **page 13**.
6. "Adjust Water Temperature" on **page 15**.
7. "Turn On The Jets" on **page 17**.

Find all settings from the Home Screen > **Settings**.

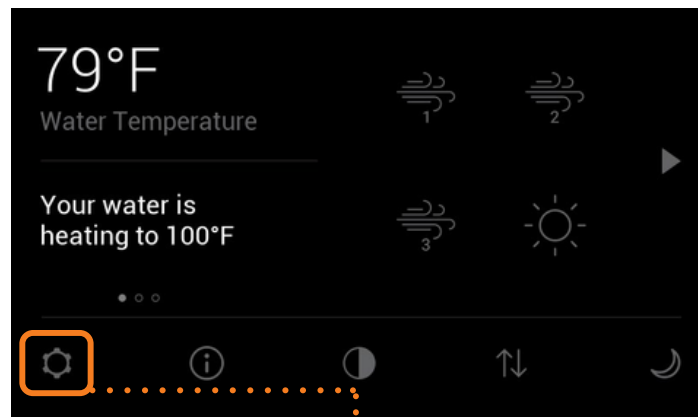

Home Screen

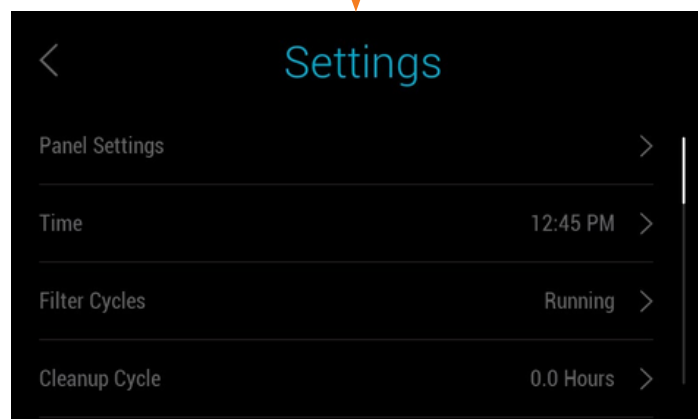

Settings Menu Screen

After you complete these essential settings, customize your preferences to suit your schedule, and have your spa ready and waiting for your enjoyment.

6 PRIME THE PUMP

Priming is a 4-minute window of time that occurs after initially powering up at installation or an outage, and is used to help clear waterflow of trapped air or possible obstructions that can strain the system.

NOTE: Features and functions available are shown here. Your system settings display may vary.

To prime the pump:

After the Spa Touch 4 powers up, watch for the prompt, "**Prime your spa.**"

The message to prime your spa displays.

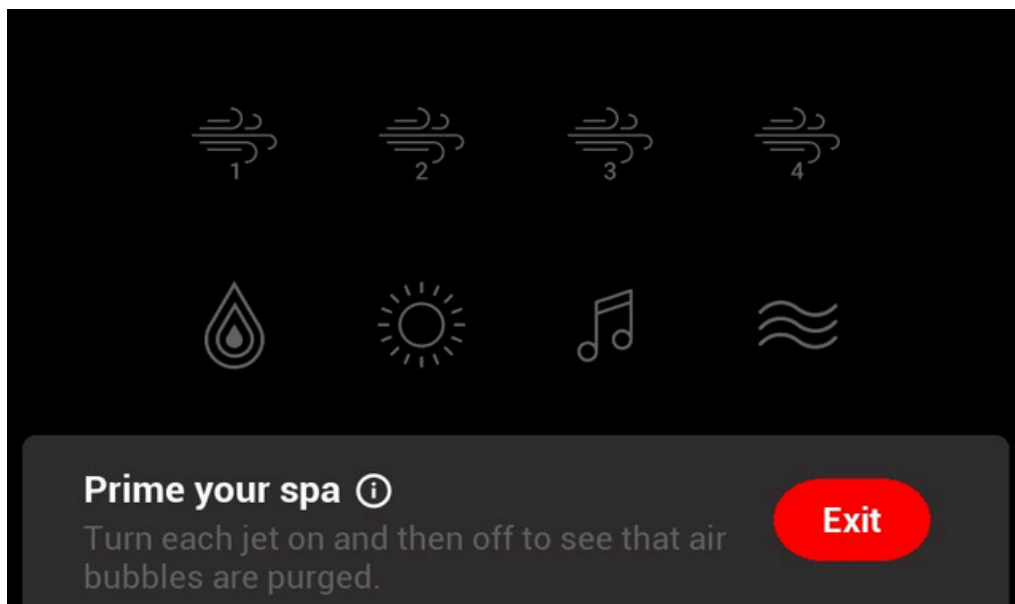

Priming Message

Touch each jet on and then off to see that air bubbles are purged and water flows smoothly.

The jets start up and clear air bubbles from the pipes.

NOTE: During priming, you can also touch other water features lit on the panel.

After priming, the spa screen displays active features your panel controls.

7 CONNECT YOUR SPA TOUCH 4

DISCLAIMERS

1. Casa Blui is not responsible for interruptions, failures, or delays in communication between the spa and Balboa's servers (ControlMySpa), as this service is provided and managed by a third party. Our scope is limited to linking the spa to the customer's app and confirming that the initial configuration is completed correctly.
1. Balboa initial server connections take up to TWO WEEKS after first request to make a proper connection.

MAIN REQUIREMENTS

- 2.4 GHz Wi-Fi is typically required (802.11 b/g/n), 5.8GHz networks may not be supported.
- Standard home router security is recommended (Open / WEP / WPA / WPA2). Enterprise-level security may not function properly.
- Router channels between 1 & 11 are commonly required.
- A strong Wi-Fi is recommended at the Spa location, ideal levels range from -50dBm to -25dBm.
- Guest hotspot networks that use login portals may bring compatibility issues.
- Enterprise authentication methods (802.1X / RADIUS / WPA/WPA2 Enterprise) may not be supported.
- Mesh router systems may not be reliable in some installations.

IMPORTANT: Connecting your Spa Touch 4 to your Wi-Fi delivers timely updates your system needs for ongoing improvements.

BEFORE YOU BEGIN: Have your Wi-Fi network and password available.

CONNECT WI-FI

To connect to Wi-Fi:

1. From Home, touch Settings G, and then scroll and touch Wi-Fi.

The Wi-Fi Screen displays "Not Connected" with available networks.

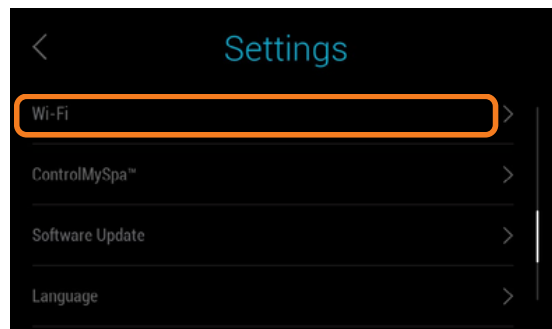

Settings Menu

Scroll and touch your Wi-Fi network to connect your spa panel.

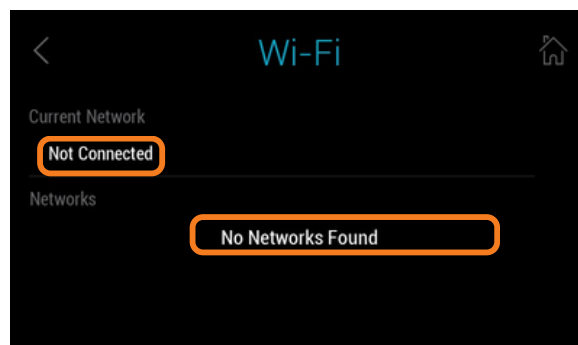

Wi-Fi Screen

A keyboard displays for you to type your network password.

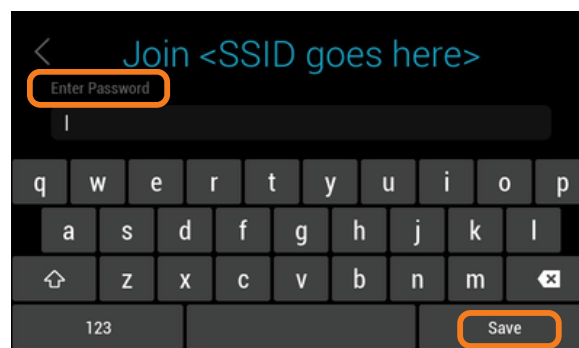

Enter Password Screen

Enter your network password and touch Save. "Attempting to connect" displays, and upon connection, the Wi-Fi.

Screen displays with your newly selected network.

Touch Back to return to the Settings Menu.

REGISTER YOUR SPA TOUCH 4

NOTE: This step is needed to establish your ControlMySpa (CMS) account, and give you access to use the CMS App from your mobile device.

CMS Code: WNZ-69070

To register your Spa Touch 4:

From the Settings Menu, touch “ControlMySpa”.

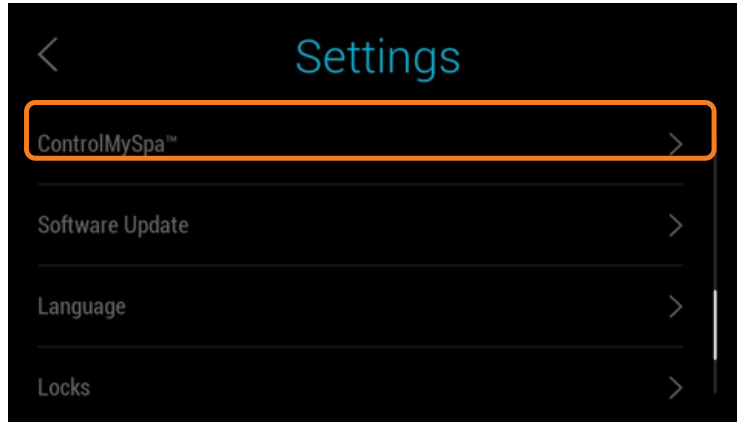

Settings Menu

The ControlMySpa Screen displays.

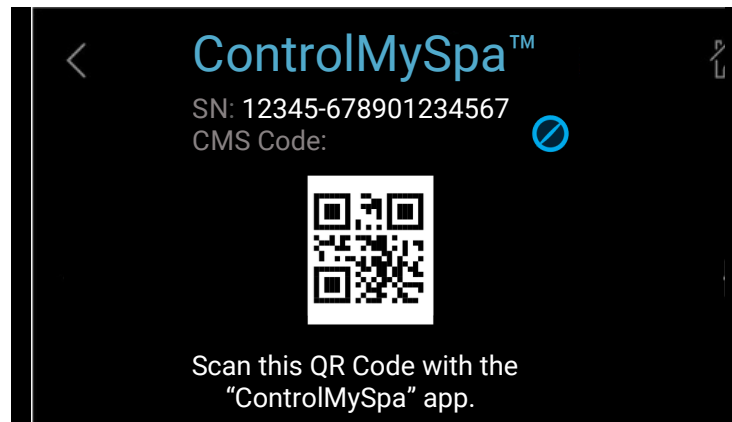

Touch the “Edit” icon , and the ControlMySpa keyboard displays.

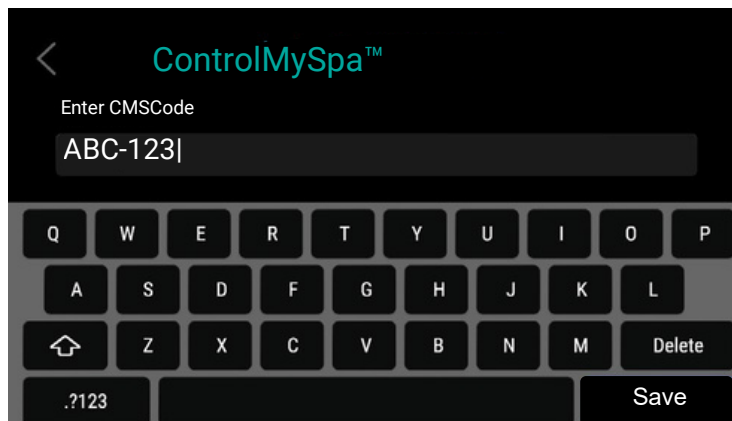

Enter the CMSCode supplied by your spa dealer, and then touch **“Save”**.

The ControlMySpa screen displays a QR code you will use to pair your spa when you establish your ControlMySpa App account.

Leave the ControlMySpa screen open on your panel to complete Spa Account Setup.

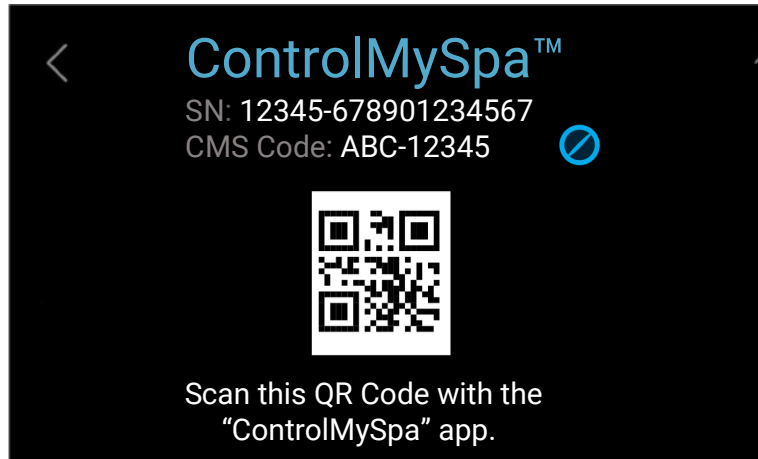

ControlMySpa Screen

Create a ControlMySpa Account

Using your mobile phone, go to your App store, and **download ControlMySpa**. (Works with iPhone models 8+ and up.)

Follow the in-app prompts to set up an account, and then Setup Spa. Be sure to set up your spa account "by QR code."

Use your phone's camera to **scan the QR code** displayed on the Spa Touch 4 panel, and complete Spa Account Setup.

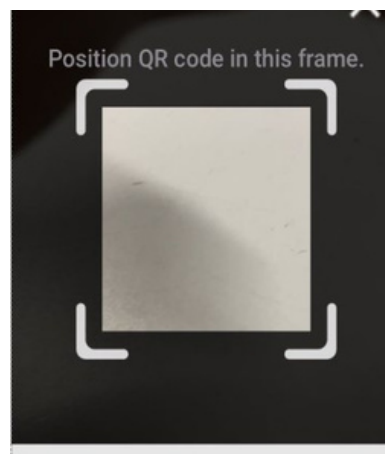

IMPORTANT: When you see "Account Setup Successful" on your mobile device, check your email to authenticate your account and complete this step.

8 SOFTWARE UPDATE

IMPORTANT: Be sure to update software for your Spa Touch 4, and keep your system current.

To check for software updates:

From Home, touch “**Settings**”, then “**Software Update**”.

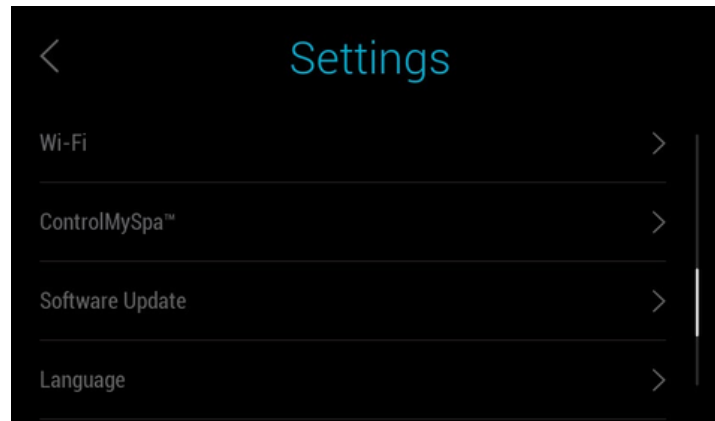

SettingsMenu

The Software Update Screen displays.
Touch “**Update**”.

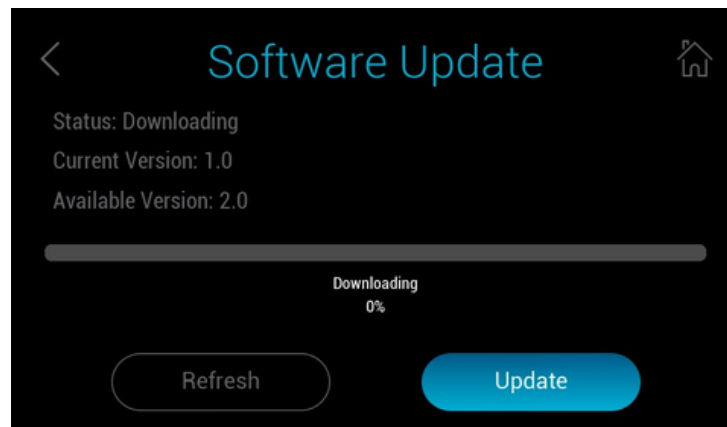

Settings Menu

The Status displays “Getting Updates”, “Downloading”, “Installing”, and “Current” when the update is complete.

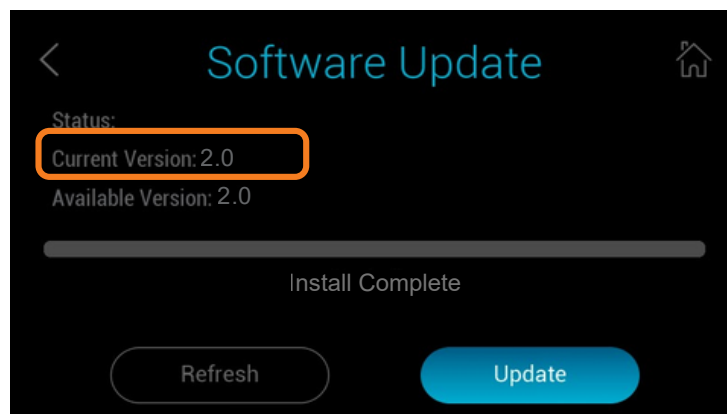

Software Update Screen

9 SET THE TIME

The time you set displays on the Quick Glance and Relax Screens, and becomes your system's time, used to automate the duration of other functions, such as filter cycles, activation and water maintenance for reliable performance.

IMPORTANT: A message button  displays when the time needs to be set, and turns off after you set the time.

To set the time:

From the Home Screen, touch **"Settings"**, then **"Time"**.

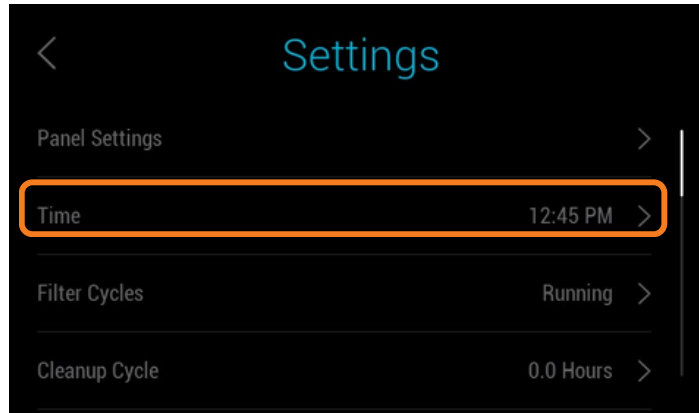

SettingsMenu

The Time Screen displays.

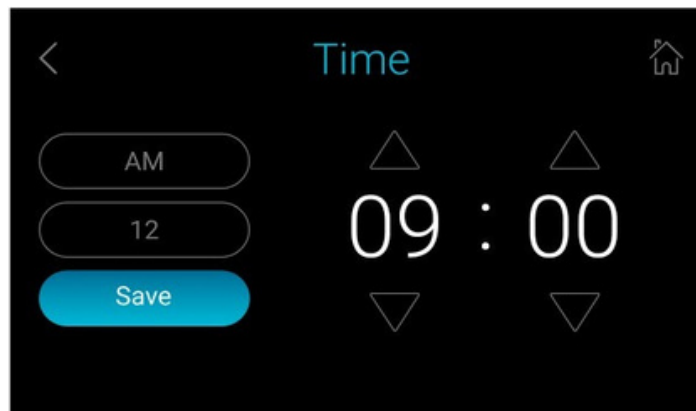

Time Screen

Touch **buttons and arrows** to the current time and **"Save"**.

The new time is saved in the system.

10 SET FILTER CYCLES

Daily filtration assures your spa is operating as designed.

To set the filter cycle times:

From the Home Screen, touch “**Settings**”, then “**Filter Cycles**”.

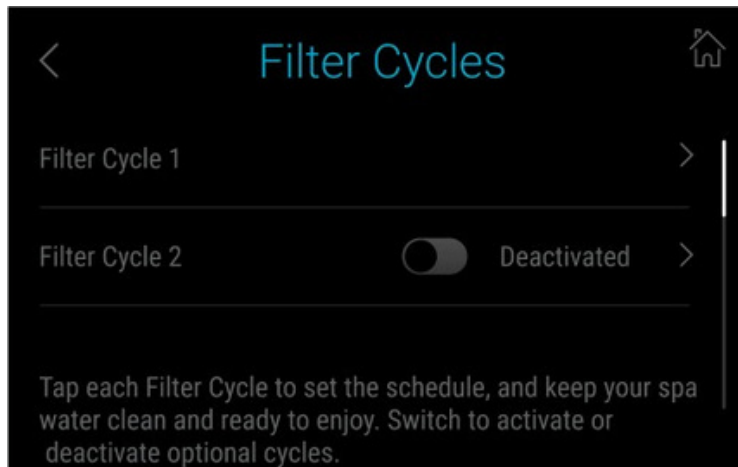

Filter Cycles

The Filter Cycles Screen displays the number of cycles you can schedule.

Touch “**Filter Cycle 1**”.

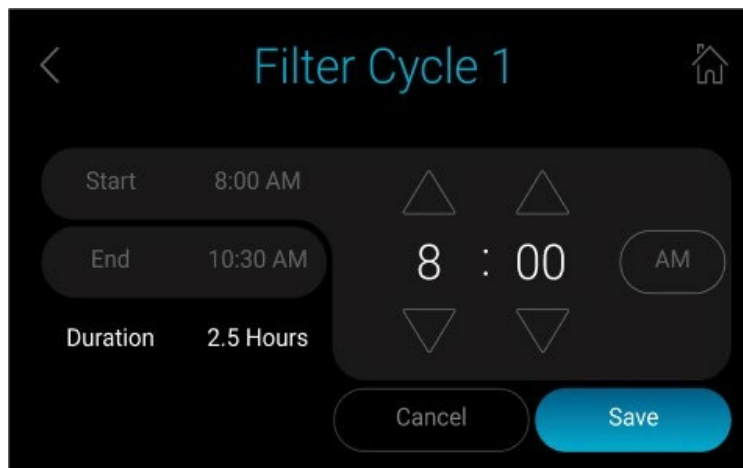

Filter Cycles

Touch “**Start**” and touch arrows to set the filter cycle starting time. Your desired filter cycle duration adjusts as you make changes.

Touch “**End**” and touch arrows to set the filter cycle ending time.

Your desired filter cycle duration adjusts as you change it.

Touch “**Save**”.

The Filter Cycles Screen displays.

Repeat steps to set additional filter cycles displayed.

Touch “**Back**” to return to the Home Screen.

SET CLEANUP CYCLE

Adjust your cleanup cycle duration for the pump to run, and keep the water clean and ready to enjoy after each use.

To set the cleanup cycle times:

From the “**Home Screen**”, touch “**Settings**”, then “**Cleanup Cycle**”.

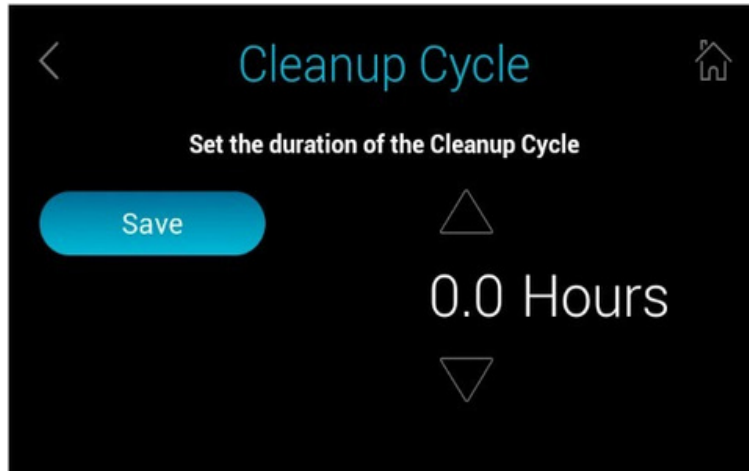

Cleanup Cycle

The Cleanup Cycle Screen displays the duration of time the pump will run after use.

Touch the **arrows** to adjust to the desired duration up to 4 hours.

Touch “**Save**”.

The new cleanup cycle duration is set.

Touch “**Back**” to return to the Home Screen.

11 ADJUST WATER TEMPERATURE

Find your current water temperature displayed in large numbers on the Water Temperature reading of the HomeScreen.

To set the desired water temperature:

From the Home Screen, touch the **“Water Temperature”** area of the screen.

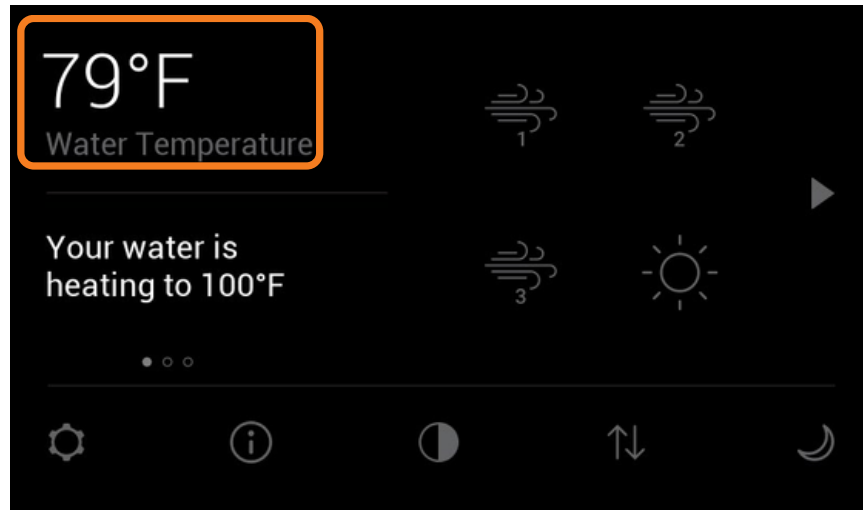

Home Screen

The Desired Temperature Screen displays.

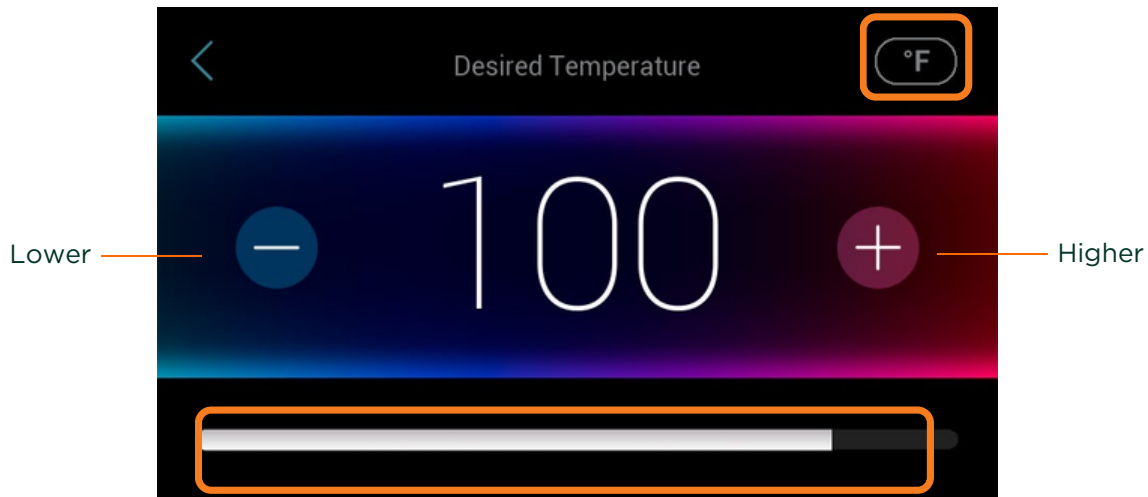

Desired Temperature Screen

Touch the **plus and minus** signs or slide the bar along the bottom of the screen for your desired temperature.

Touch the **unit of measure**, upper right, to change between Fahrenheit (°F) or Celsius (°C) as the water temperature unit of measure.

The system begins to adjust to the newly set temperature. Touch **“Back”** to return to the Home Screen.

12 START SPA HOLD

Use this setting for temporary servicing or maintenance. When started, it pauses all spa activities for 1 hour.

To start Spa Hold:

From the Home Screen, touch “Settings”.

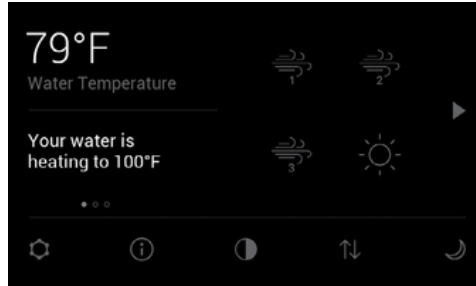

Home Screen

The Settings Menu displays.

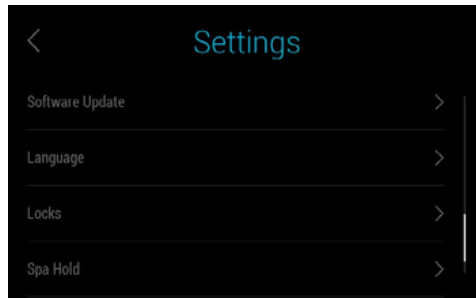

SettingsMenu

Scroll and touch “Spa Hold”.

The Spa Hold Screen displays.

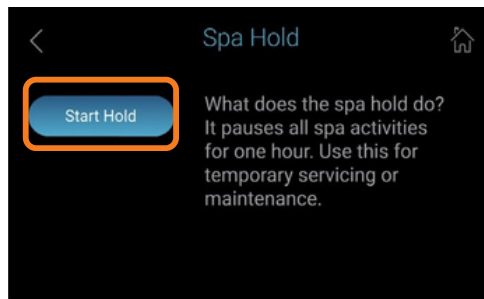

Start Hold

Touch “Start Hold”

The Spa pauses displaying the minutes remaining on hold.

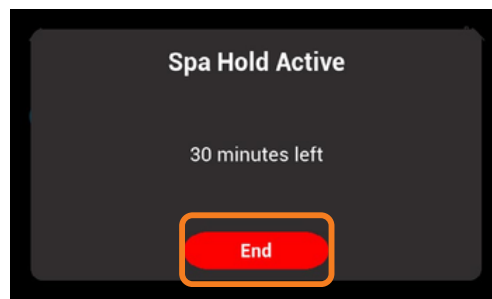

Start HoldActive

You can end the “hold” by touching **Exit**.

13 TURN ON THE JETS

*NOTE: Features and functions available are shown here. **Your system display may vary.** Turning on the jets provide the water pressure and motion for an enhanced, therapeutic soak.*

To turn on the jets:

From the Home Screen, touch the available **Jet** to activate, and touch the **arrow** to see more features.

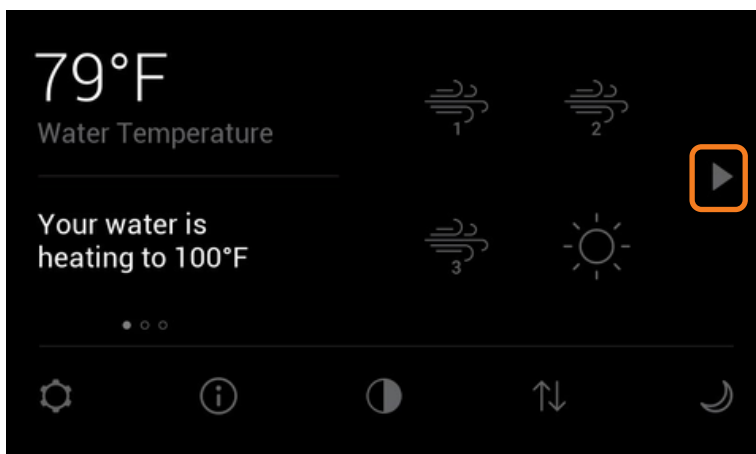

Home Screen

The spa features display with additional components connected to your system.

Touch on **each jet** for as many jets you want to activate, and the desired speed your system provides.

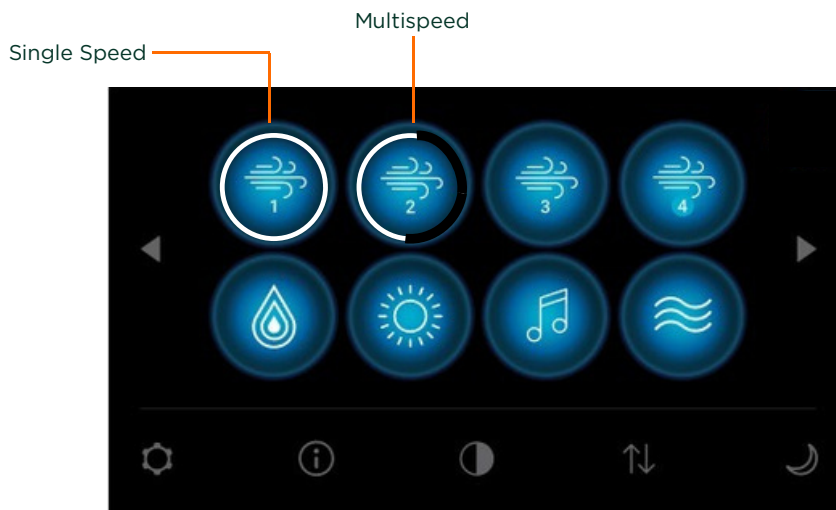

Spa Selections - **EXAMPLE**

Touch the **arrows** to display the Home Screen.

14 ADJUST SCREEN BRIGHTNESS

Adjust your panel display brightness.

To change the display brightness:

From the Home Screen, **Settings**, touch **Panel Settings**.

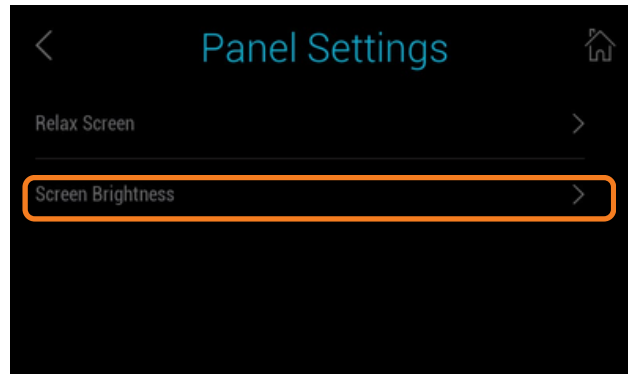

Panel Settings

The **Screen Brightness** with the brightness slider along the screen bottom.

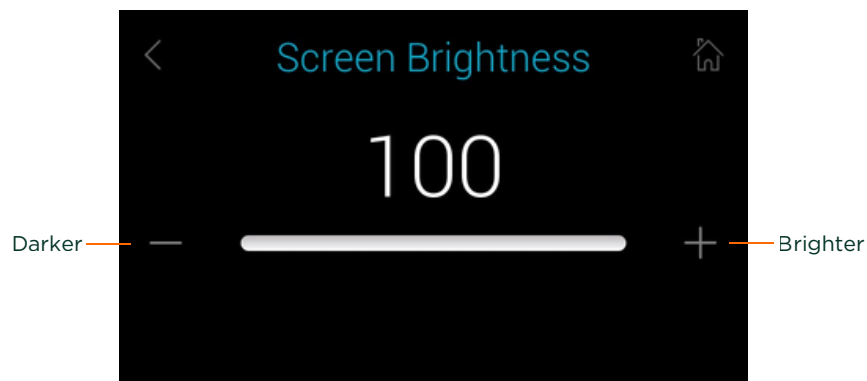

Screen Brightness

Touch the **plus** and **minus** signs or slide the bar on the screen to adjust your desired level of brightness.

Touch **Home** to return to the Home Screen.

15 HEAT MODE & TEMP RANGE

NOTE: Features and functions available are shown here. Your system display may vary.

Keep your spa heated with these options: Run the spa as continuously regulating heat in a Ready state or as energy efficient in a Rest state.

HEAT MODE:

From the Home Screen, touch Settings G, then Heat Mode.

The Heat Mode Screen displays.

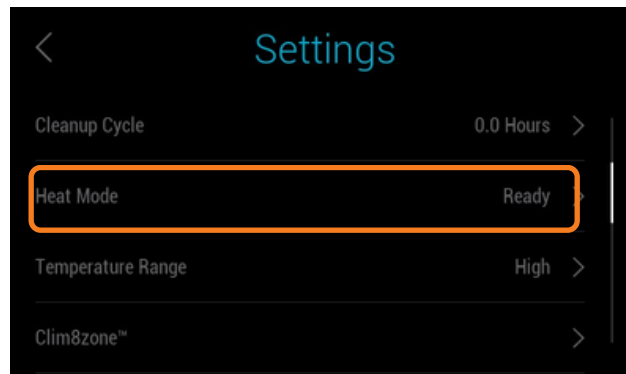

Home Screen

Touch buttons to change the Heat Mode.

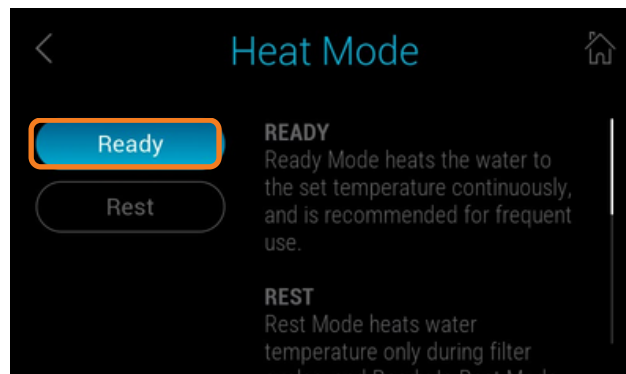

Heat Mode

Options are:

Ready - Regulates temperature continuously, and best for frequent, scheduled use.

Rest - Regulates temperature only during filter cycles.

Ready-In-Rest - When your spa is in Rest Mode, and you touch Jet 1, the system switches to Ready-In-Rest Mode and heats the water to the desired temperature for one hour.

Then, the spa returns to Rest Mode.

NOTE: To cancel Ready-In-Rest and return back to Rest Mode within the hour, perform step 2 and touch Ready button.

Touch "**Home**" to return to the Home Screen.

TEMPERATURE RANGE:

IMPORTANT

THE TEMPERATURE RANGE SHOULD BE CHANGE ON COLD WEATHERS OR FOR LONG PERIODS OF NON USE.

YOU CAN CHANGE IT BACK TO “HIGH” WHEN YOU ARE GOING TO USE IT.

THIS WILL PRESERVE THE SPA LIFE AND SAVE ELECTRICITY.

Choose a range for your Desired Temperature setting, and that becomes the range displayed for setting spa water temperature. For example, choosing High may display a range from 80° F as the lowest degree, and 104° F as the highest of the High range.

To change the range between High and Low:

From the Home Screen touch Settings, then **Temperature Range**.

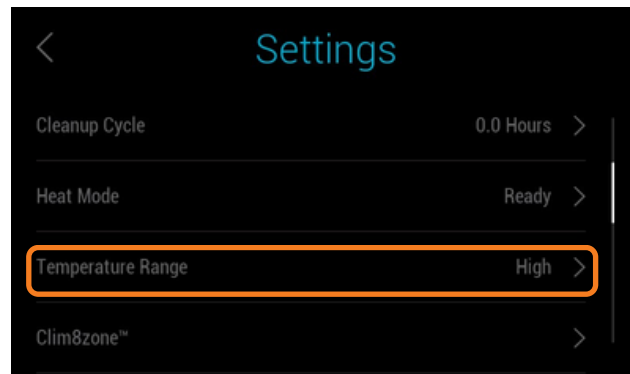

Settings Menu

The Temperature Range Screen displays.

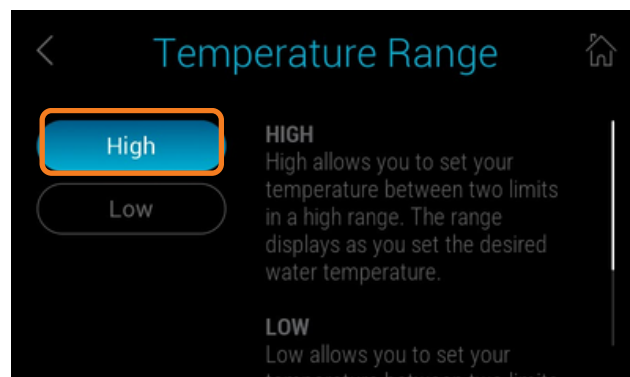

Temperature Range

Touch either **High or Low** to choose what range displays in the Desired Temperature Screen.

Your selected range displays as the limits of your Desired Temperature Screen.

Touch Home to return to the Home Screen.

16 SET LOCKS

Restrict panel access and changes to water temperature setting by setting the locks.

To change the security setting:

From the Home Screen, touch Settings and scroll to **touch Locks**.

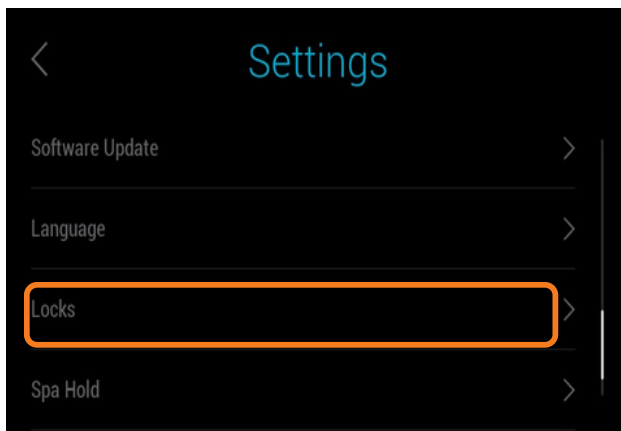

Settings Menu

The Locks Screen displays two types of locks you can set:

Settings Lock - This lock restricts access to controls, including water temperature and scheduled maintenance functions, in order to maintain spa water quality and safety of your spa guests.

Panel Lock - This lock restricts preferential and personalize settings that affect the individual spa experience, including what is displayed on the panel and panel access to make changes to settings.

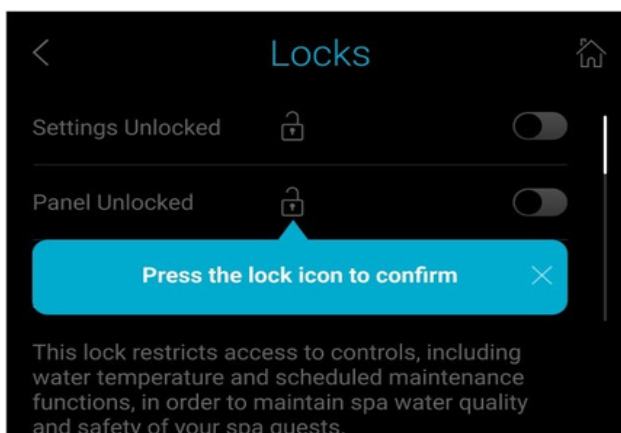

Locks Screen

Touch the **off / on** toggle.

The message displays, "**Press the lock icon to confirm**".

Touch the **Lock icon**.

The selected lock displays **locked / unlocked**.

Repeat the steps to change the setting again.

17 SET LANGUAGE

You can set a different language for the text in the panel screen display.

To set a different language:

From the Home Screen, touch Settings and scroll to touch Language.

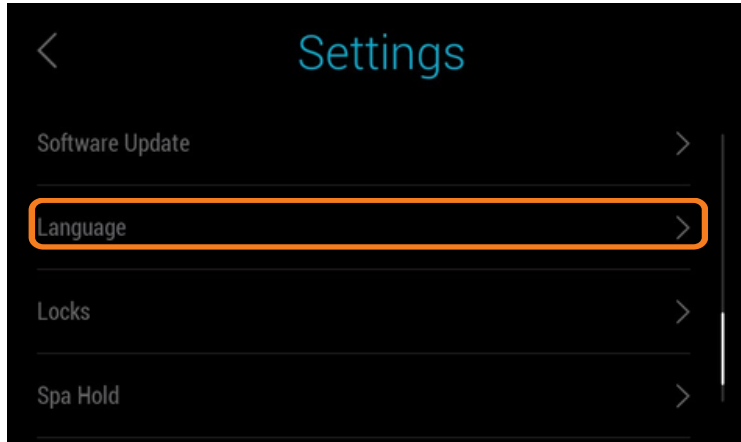

Settings Menu

The Language Menu displays.

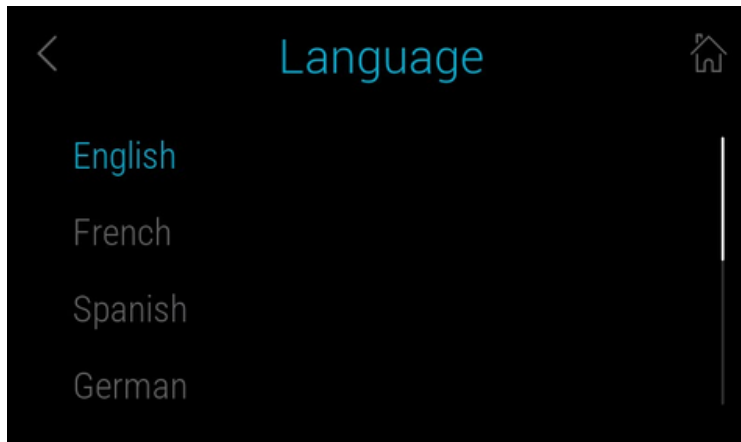

Language Menu

Touch your **desired language** to use in the panel screens.

Your selection is indicated in **blue** and the new language displays in the panel.

Touch **Back** until the Home Screen displays in your selected language.

18 DIAGNOSTICS

Find your system settings and fault log record here.

To find your system Information:

From the Home Screen, touch Settings, and scroll to touch “Diagnostics”.

The Diagnostics Menu displays access to two status pages:

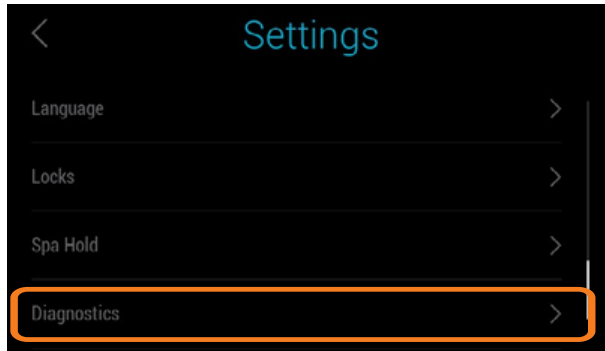

Settings Menu

Touch **System Information** or **Fault Log** to see corresponding displays.

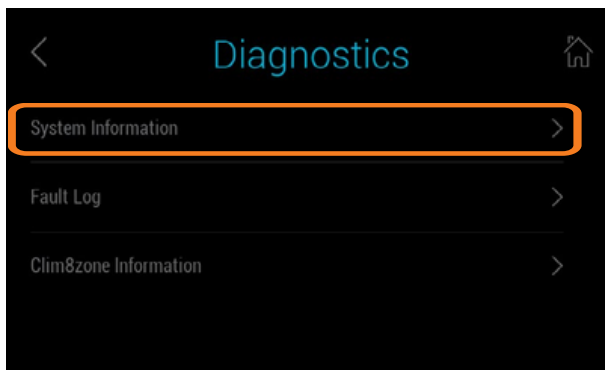

Diagnostics Menu

Your selected information displays.

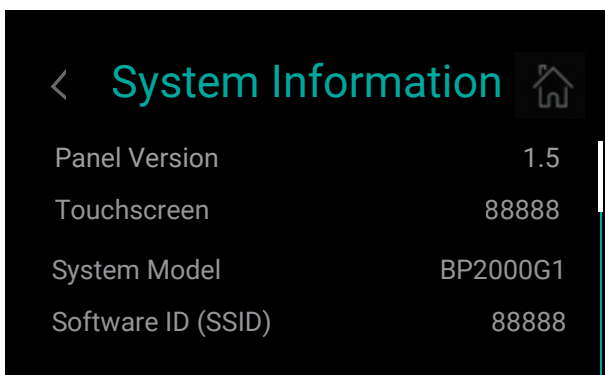

System Information Example

19 SPA INFORMATION

To find your spa information:

From the Home Screen, touch the iMessage



The Spa Information Screen displays.

GENERAL MAINTENANCE

1	SAFETY & MAINTENANCE WARNINGS	49
2	STAINLESS STEEL SHELL CARE	49
3	WATER MAINTENANCE	50
4	FILTRATION	51
5	CHEMICAL ANALYSIS	52
6	WATER DISINFECTION	54
7	SPECIAL PRODUCTS USE	54
8	QUICK REFERENCE TABLES	55

1 SAFETY & MAINTENANCE WARNINGS

Before performing any electrical or mechanical work, switch OFF power at the breaker and secure the system against restart (lock-out/tag-out where applicable).

Do not handle or service the equipment with wet hands or feet.

Allow components to cool before touching them.

Use only manufacturer-approved parts and follow all product instructions.

2 STAINLESS STEEL SHELL CARE

Use mild, non-abrasive household cleaners suitable for stainless steel. For routine cleaning, use a soft cloth or non-scratch sponge with a little soap and warm water. Rinse thoroughly and dry with a clean microfiber cloth.

If using any commercial cleaner, confirm it is specifically recommended for stainless steel by its manufacturer. Always spot-test in an inconspicuous area first.

Never use abrasive powders, steel wool, scouring pads, or harsh polishing compounds that can scratch the surface or damage the finish.

Keep the stainless steel away from chlorides or chlorine-based cleaners (e.g., bleach), hydrochloric or muriatic acid, harsh descalers, and other corrosive chemicals that may cause staining, pitting, or corrosion.

Wipe away dust, fingerprints, and smudges with a soft, slightly moist cloth; dry immediately to prevent water spots.

Remove grease, oil, paint, and ink marks with isopropyl alcohol (up to 70%) or a stainless-steel-safe solvent cleaner. Apply with a soft cloth, then rinse with water and dry with a clean cloth.

Do **not** use razors, scrapers, or any sharp tools on the stainless steel.

For light surface marks, use a non-abrasive stainless steel polish or cleaner. Rub gently with a clean cloth, following the direction of the grain, and follow the product instructions. Avoid waxes or polishes that may leave slippery residue on areas contacted by bathers.

Weekly: Clean the sections of the spa **above the waterline** (areas not submerged) and, if desired, apply a spa-safe stainless steel polish to maintain appearance. Do not polish floor or seating areas where slip resistance is important.

ATTENTION: *Never leave the spa uncovered, empty, and exposed to direct sunlight. Prolonged UV and heat can cause warping, discoloration, and surface damage that is not covered by the warranty. If the spa must be drained, keep it shaded and covered, and refill promptly.*

3 WATER MAINTENANCE

Water maintenance is one of the areas that requires the greatest attention due to its impact on safety, comfort, and equipment longevity. The specific actions and frequency depend on the mineral content of the fill water, how often the spa is used, and the number of people using it.

The most important thing to keep in mind is that the **water should be changed every 6 months.**

The three main points to consider are:

- **Filtration**
- **Chemical Analysis**
- **Disinfection of the water**

SAFE HANDLING AND USE OF CHEMICAL PRODUCTS

Before using any chemical product, always read the instructions on its product label and follow the manufacturer's recommendations.

- Assign one trained person to handle all spa chemicals.
- Keep products out of reach of children and pets.
- Measure carefully and add only the recommended amount.
- Store in sealed containers, in a cool, dry, well-ventilated place, away from sunlight.
- Avoid breathing vapors or dust; prevent contact with skin, eyes, and mouth.
- Wash hands thoroughly after handling chemicals.
- In case of spills or exposure, follow the emergency directions on the product label.
- Keep away from flames, sparks, and smoking areas — many products are flammable.
- Never store chemicals inside the spa cabinet or near electrical components.
- Add chemicals to water one at a time, allowing time between doses to prevent reactions.
- Do not add products while people are in the spa.
- Test water daily for pH and sanitizer levels during frequent use.
- Use only products specifically designed for spas or hot tubs.
- Dispose of containers safely, following local waste regulations.

4 FILTRATION

REGULAR MAINTENANCE

Rinse the filter cartridge with a gentle garden-hose stream **every 1-2 weeks** with heavy use (daily/large family) or about monthly with lighter use. A quick rinse between the pleats removes hair, lint, and fine debris to keep water flow strong. If oils/lotions build up, a spray-on filter cleaner can be used for a quick degrease before rinsing.

Do not use dish soap, bleach, or household cleaners—they leave residue and can damage the media.

To access the filter, remove the filter cap next to the display, then unscrew the top section of the filter housing.

How to clean it:

1. Turn power off and remove the cartridge(s).
2. Hose from top to bottom, spreading the pleats with your fingers or a hose attachment so water reaches the inner folds. Avoid pressure washers or dishwashers.
3. Optional: apply an instant/spray filter cleaner, wait the labeled contact time (typically a few minutes), then rinse thoroughly.
4. Reinstall when fully rinsed.

DEEP SOAK CLEANING

Perform a chemical soak to remove embedded oils, soap film, and minerals about once a month for heavy use or every 2-3 months for lighter use.

Also tie a deep soak to each drain/refill. Allow the cartridge to air-dry fully before reinstalling.

How to do it:

1. Fill a clean bucket with water and add filter-cleaner per its label.
2. Submerge the cartridge fully and soak several hours
3. Rinse until runoff is clear and let the filter dry completely before putting it back.
4. Any cleaner left in the media can cause foaming.

REPLACEMENT SCHEDULE

For standard pleated cartridges, plan on:

- **Typical residential use:** about 12-24 months.
- **Light use/very clean water:** up to 24-36 months.
- **Heavy use/commercial or frequent parties:** 6-12 months.

Replace earlier if you see tears, frayed or flattened pleats, cracked end caps, persistent discoloration/odor after cleaning, or chronically reduced flow.

5 CHEMICAL ANALYSIS

For optimal spa performance and low-maintenance water, keep pH, alkalinity, and hardness within the recommended ranges. Test these parameters regularly and adjust as needed to maintain proper balance.

- **pH:** Maintain between 7.4 and 7.6 for disinfectants to work effectively.
- **Alkalinity:** Keep between 80 - 125 ppm to stabilize pH and protect equipment.
- **Hardness:** Keep between 100 - 200 ppm.

Balanced water ensures it remains clear, clean, and easy to manage over time.

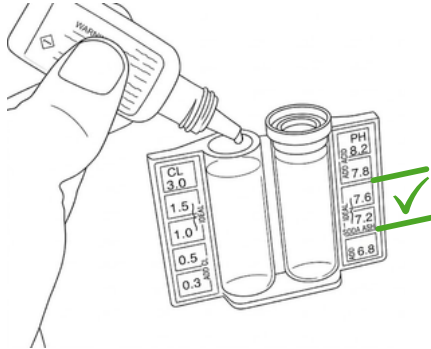

Water Hardness Scale

Grains/Gal	mg/L & ppm	Classification
Less than 1	Less than 17.1	Soft
1 - 3.5	17.1 - 60	Slightly Hard
3.5 - 7	60 - 120	Moderately Hard
7 - 10	120 - 180	Hard
over 10	over 180	Very Hard

Water Source: Tap vs. Well

Maintaining clean, high-quality water is essential for both spa hygiene and long-term durability.

- Tap water is generally safe, as it is microbiologically treated and free from most metals, organic matter, and other impurities that could harm the spa.
- Well water, on the other hand, can contain oxides, dissolved metals, organic debris, and bacteria. These can encourage algae growth and lead to staining, scaling, or other damage to the spa’s surfaces and components.

For best results, use treated tap water or properly filtered and disinfected well water before filling your spa.

Water Hardness

It reflects the total dissolved calcium in the water. It influences how corrosive or scale-forming the spa water is.

Very low hardness (“soft” water) is not recommended because it’s aggressive to equipment and can stain the shell.

Very high hardness (“hard” water) promotes scale on surfaces and components.

If hardness is too high:

- Lower it by dilution—use a mix of roughly 75% hard water + 25% soft water as a starting point.
- If soft water isn’t available, dose a stain/scale control product as directed on its label.

If hardness is too low:

- Avoid filling with soft water; raise hardness by topping up with a higher-calcium (harder) source.
- Once hardness is in range, it generally stays stable unless you add water that’s much harder or softer.

Water Alkalinity

Alkalinity refers to the concentration of alkaline compounds (such as carbonates, bicarbonates, and hydrates) dissolved in the water.

When alkalinity drops below 80 mg/l or rises above 125 mg/l, pH can become unstable, making it harder to maintain proper water balance.

If below 80 mg/L, add an **alkalinity increaser** ; if above 125 mg/L, lower with small doses of **pH decreaser or partially dilute with fresh water**. Run the pumps to circulate, then retest. Be sure the products are compatible with hot tubs.

Water pH

It measures the level of hydrogen ions (H⁺) in the water, indicating its acidity or alkalinity. The recommended range is between 7.4 and 7.6 (neutral is 7). Maintaining this range helps:

- Protect bathers' comfort — the skin, eyes, and mucous membranes are close to this natural pH level.
- Extend the lifespan of the spa's surfaces and components.
- Ensure sanitizing chemicals work effectively, reducing overall product use.

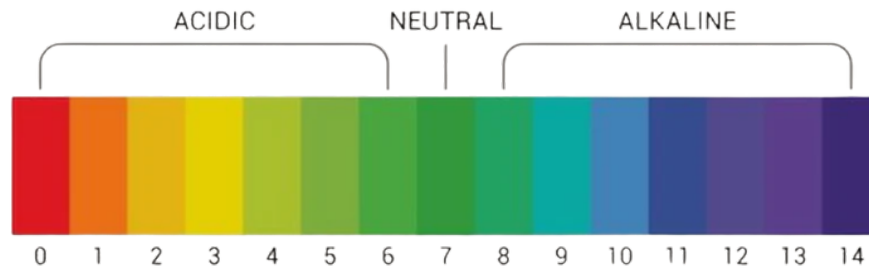

If below 7.4, add a **pH increaser** (Sodium Hydrogen Carbonate); if above 7.6, add a **pH decreaser** (Sodium Bisulfate). Run the pumps to circulate, then retest. Be sure the products are compatible with hot tubs.

QUICK REFERENCE

Steps	Parameter	Ideal Range (ppm) – Minimum	Ideal Range (ppm) – Maximum	What Chemicals to Use — To Raise	What Chemicals to Use — To Lower
1	Total Alkalinity	80	125	Sodium Hydrogen Carbonate, or Sodium Bicarbonate	Sodium Bisulfate
2	Calcium Hardness	100	200	Calcium Hardness Increaser	Use a mixture of 75% hard water and 25% soft water or use a Stain and Scale Inhibitor
3	pH	7.4	7.6	Sodium Hydrogen Carbonate	Sodium Bisulfate

6 WATER DISINFECTION

Maintaining the correct disinfectant level is essential to eliminate algae, bacteria, and other microorganisms that can develop in spa water. Overdosing should be avoided, as it may cause skin or eye irritation and can affect the spa's components.

The recommended primary disinfectant is bromine tablets, placed in the pre-filter or a suitable feeder to dissolve gradually and provide a constant residual in the water. Test the bromine concentration daily using an appropriate analyser kit, and ensure it remains within the range of **2.2 to 3.3 ppm**.

If chlorine is used instead, maintain free residual chlorine between **0.5 and 1.5 ppm**. Always add chemicals separately and with no bathers in the spa.

When the sanitizer level is below the recommended range, increase dosing and allow the water to circulate thoroughly before re-testing. If the level is above the range, circulate with the cover open to allow dissipation, or dilute with fresh water as necessary.

Secondary systems such as ozone or UV can support oxidation and water clarity but must never replace a continuous bromine or chlorine residual. All test results and corrective actions should be documented as part of the spa's maintenance records, and any stricter local regulations should take precedence.



7 SPECIAL PRODUCTS USE

Beyond the main sanitizer program, the following spa-specific products help keep water and surfaces in good condition. Use as directed by the manufacturer.

- **Scale inhibitor:** Prevents calcium scale, especially in hard-water areas. Dose weekly and after every water change.
- **Algaecide:** Suppresses algae growth in the spa water. Add weekly and each time the water is renewed.
- **Foam remover:** Controls foam caused by aeration and body oils. Use only when noticeable foam appears.
- **Grease/line cleaner:** Removes the oily ring on spa walls. For best results, drain the spa, apply with a sponge to the affected areas, then rinse immediately with plenty of water.

8 QUICK REFERENCE TABLES

PRODUCTS QUICK REFERENCE

Product	Reason for use	Frequency of use
pH ADJUSTER	Use when pH is outside 7.4–7.6: if above, add pH Minor; if below, add pH Major.	Check pH daily with a test kit.
BROMINE TABLETS	Add if the bromine residual is below the recommended range (2.2–3.3 ppm).	Test bromine daily with a Br test kit.
LIMESCALE REMOVER	Prevents formation of calcium scale.	Once per week and after each water change .
ALGAEICIDE	Prevents algae growth in the water.	Once per week and after each water change .
GREASE REMOVER	Removes oily/dirt rings on spa walls.	Whenever deposits are observed ; scrub with a sponge and rinse immediately with plenty of water.
FOAM REMOVER	Treats visible foam on the water surface.	Whenever foam appears in the water.

FILTRATION

Task	When (Residential)	Notes
Quick hose rinse	Every 1–2 weeks with heavy use; about monthly with lighter use	Gentle garden-hose stream between pleats; avoid pressure washers/dishwashers.
Spray cleaner (instant)	About monthly or whenever oily film builds up	Apply, wait label contact time, then rinse thoroughly.
Deep soak (chemical)	Monthly with heavy use; every 2–3 months with lighter use; also at each drain/refill	Fully submerge in filter-cleaner solution for several hours to overnight; rinse until runoff is clear; air-dry fully before reinstalling.
Rotate spare filter	Whenever you deep-clean	Keep a second cartridge to avoid downtime while one dries.
Replace cartridge	Typically 12–24 months (light use up to 24–36 months ; heavy use 6–12 months)	Replace sooner if tears, flattened pleats, cracked end caps, persistent discoloration/odor, or chronically reduced flow after cleaning.

CHEMICAL ANALYSIS

Parameter / Action	When (Residential)	Target / Guidance
Test pH	Daily during frequent use; otherwise regularly	Keep 7.4–7.6 ; adjust with spa-compatible pH increaser/decreaser; circulate and retest.
Test Total Alkalinity	At start-up and after major top-ups or when pH won't hold	Keep 80–125 ppm to stabilize pH; adjust with alkalinity increaser or small doses of pH decreaser/dilution.
Test Calcium Hardness	At start-up ; reassess after significant water additions or if scaling/corrosion signs appear	Keep 100–200 ppm ; if high, dilute or use stain/scale control; if low, raise hardness (avoid prolonged “soft” water).

DISINFECTION OF THE WATER

Task	When (Residential)	Target / Guidance
Maintain primary sanitizer (bromine tablets in feeder/prefilter)	Continuous; test daily	Keep 2.2–3.3 ppm bromine; add tablets/adjust as needed. If low, increase dosing and circulate; if high, circulate with cover open or dilute; never add chemicals with bathers in spa.
(If using chlorine instead)	Continuous; test daily	Keep 0.5–1.5 ppm free chlorine.
Support products (if used): scale inhibitor; algaecide	Weekly and after every water change	Follow product labels; these support clarity/scale control but do not replace a sanitizer residual.
Foam remover; grease/line cleaner	As needed ; grease/line cleaner best used during a drain	Use only when foam appears; for grease line, apply while drained and rinse well.
Ozone/UV (secondary)	Continuous (if equipped)	Aids clarity/oxidation but never replaces bromine/chlorine residual. Document test results and actions.



CASA BLUI

Casa Blui
Operational Headquarters: Miami, Florida, USA
Phone (+1) 954-737-2952
sales@casablui.com / www.casablui.com