

treesse

spa

Muse GP



Pre-installation manual

READ AND FOLLOW ALL INSTRUCTIONS

Proper preparation of the premises and systems will ensure a safe and rapid installation of the spa. For this reason we advise you to read this manual carefully and to carefully follow all the information contained herein.

⚠ WARNING

REDUCE THE RISK OF ELECTROCUTION

1. Never place an electric appliance within 5 feet of the spa.

REDUCE THE RISK OF CHILD DROWNING

1. Supervise children at all times.
2. Attach spa cover after each use.

REDUCE THE RISK OF OVERHEATING

1. Check with the doctor before to use if pregnant, diabetic, in poor health, or under medical care.
2. Exit immediately if uncomfortable, dizzy, or sleepy. Spa heat can cause hypertermia and unconsciousness.
3. Spa heat in conjunction with alcohol, drugs, or medication can cause unconsciousness.

WHEN PREGNANT , soaking in hot water for long periods can harm your fetus. Measure water temperature before entering.

1. Do not enter spa if water is hotter than 100° F (38° C).
2. Do not stay in spa for longer than 10 minutes.



1	1 MEASUREMENTS AND TECHNICAL SPECIFICATIONS	4
	TEMPORARY POSITIONING	5
2	WHAT PREPARATIONS ARE REQUIRED?	6
	PREPARATION OF CONNECTION TO AN OPTIONAL EXTERNAL EXCHANGER (NOT SUPPLIED)	7
	ARRANGEMENT FOR CONNECTION TO AN OPTIONAL OUTDOOR SPA PACK	8
3	IDENTIFICATION OF THE INSTALLATION SITE	8
	OUTDOOR INSTALLATION	8
	INDOOR INSTALLATION	8
	FREESTANDING INSTALLATIONS	9
4	PREPARATION OF THE INSTALLATION SITE	9
	BUILT-IN INSTALLATIONS	10
5	CHARACTERISTICS OF THE WATER SUPPLY	11
	TAP WATER AND WELL WATER	11
	WATER HARDNESS	11
	WATER ALKALINITY	11
	CHARACTERISTICS OF THE WATER SUPPLY	12
6	ELECTRICAL PREPARATIONS	12

1 MEASUREMENTS AND TECHNICAL SPECIFICATIONS

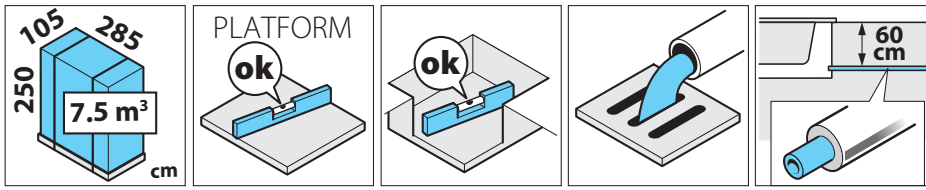

Packaging

Freestanding

Recessed

Drain

Pipe insulation

The manufacturer suggests a minimum load of 450 kg/m².

280 x 235 x 98 cm
(110.24 x 92.52 x 38.58 inches)

maximum water content	2500 litres (660 gal)
weight with water	2950 kg (6503 lb)
weight when empty	450 kg (992 lb)
Volt	2 X 120V
maximum total absorption	10.7 kW
whirlpool motor	2.024 kW
circulation motor	0.69 kW
airpool motor (only for BA02)	0.8 kW
whirlpool motor	2.3 kW
temperature control	5.5 kW
filtering system	paper
operating temperature	-5 °C min +45 °C max

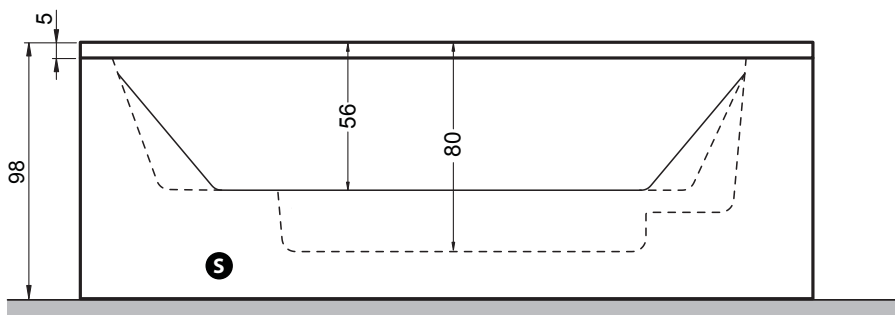
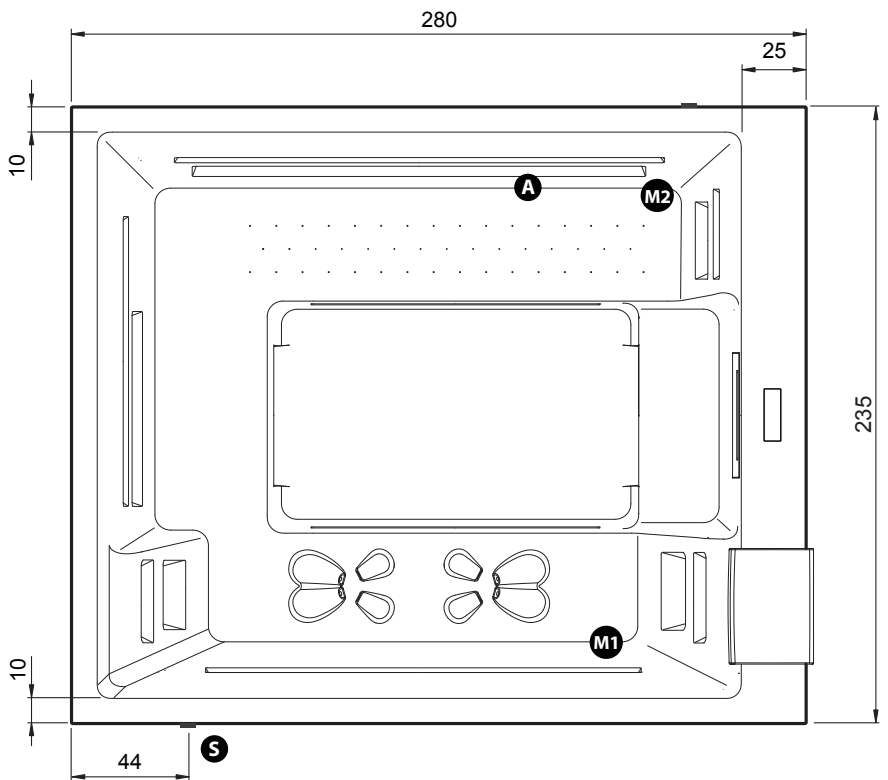

- S** drain
- M1** motor for whirlpool tub
- M2** motor for whirlpool tub
- A** airpool motor (only for BA02)

Size in cm
dimensional tolerances ± 5mm.

The manufacturer reserves the right to make improvements to the equipment at any time, without prior notice.
Partial reproduction without the manufacturer's consent is prohibited. Measurements are purely indicative and not binding.
The original language of this manual is Italian: the Manufacturer is not responsible for any mistakes in translation/interpretation.

The spa works efficiently and safely if it is installed correctly and in compliance with the regulations in force in the country of use.

This pre-installation guide provides information for a proper preparation of the environments and the plumbing and electrical connections.

This allows for a quick and safe installation.

The pre-installation stages involve the following professionals:

- A construction engineer for the calculation of the loading capacity of the platforms or floors;
- A qualified and certified company that will prepare the installation site according to the instructions provided in this guide, following current work safety regulations;
- Certified and qualified electrician who prepares electrical systems in compliance with local and national regulations regarding civil and industrial systems;

The user must promptly notify the professionals of any existing underground obstacles like gas or water lines and electrical or telephone cables.

Upon completion of pre-installation all these specialists must issue a declaration of conformity of the systems installed. Without such document, the Manufacturer declines any responsibility for damage to the systems or premises where the spa will be installed.



We recommend checking with the appropriate municipal offices to see if there are constraints that prevent installation or if permits are required.



An incorrect pre-installation could cause structural damage to the spa and void the warranty.

TEMPORARY POSITIONING



The installation of the spa should be done immediately upon receipt.

In any case, once unpacked, if it is necessary to temporarily place it on a surface awaiting the installation, it will be necessary to place level concrete slabs having a minimum thickness of 5 cm under the entire bottom of the spa.

Since the temporary base may shift, it is recommended to leave the spa in that position for the shortest possible time.

Do not leave the empty spa in DIRECT SUNLIGHT. The surface temperature could rise above 80°C resulting in serious damage, including cavitation and the deformation of the surface and components. Damage caused by direct exposure to sunlight is not covered by the warranty. In such conditions place a cover (fixed or mobile) to protect the spa.

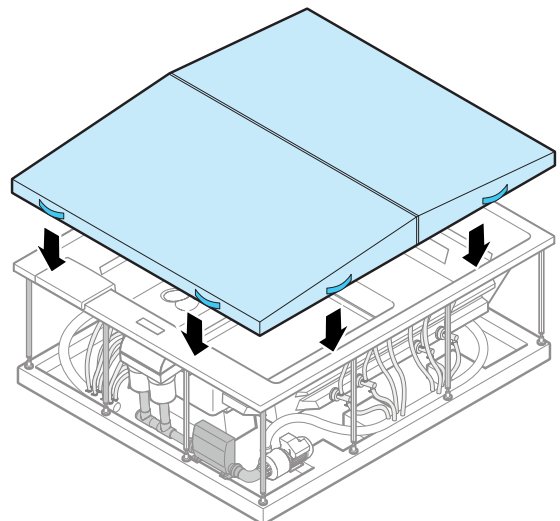
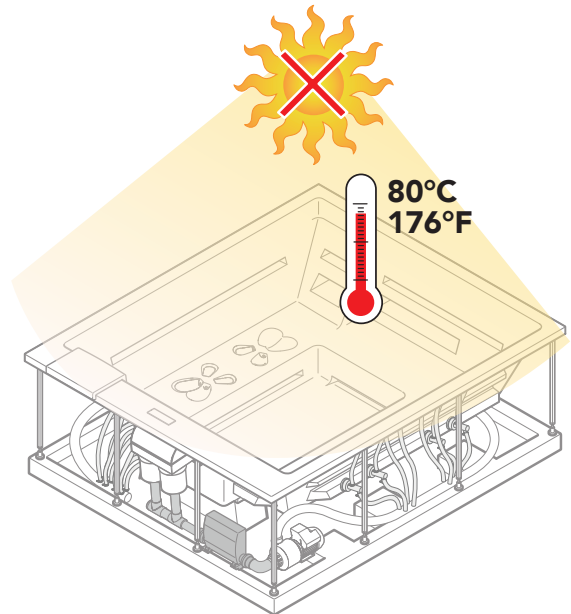

Please note

The Manufacturer cannot be held responsible and **does not recognise the warranty** in the case of:

- **Installations or connections that are not compliant** or that are carried out without following the national regulations concerning civil and industrial installations;
- **Pre-installation and installation carried out by unqualified personnel** or otherwise **not in compliance** with the instructions in the pre-installation and installation manuals;
- **Incorrect preparation of the installation environments**, including the supporting surface;
- **accidents and damage** due to a non-compliant installation or use of the bathtub;
- **Masonry works** that prevent the removal and handling of the spa or defective parts thereof.

2 WHAT PREPARATIONS ARE REQUIRED?

To be installed, the spa requires:

- 1 Identification of the installation site.
- 2 Preparation of the installation site.
- 3 Preparation of the drain.
- 4 Preparation of the electrical system.
- 5 a possible external heat exchanger (optional), see next page for details.

The following pages will provide detailed explanations of how to perform these preparations.

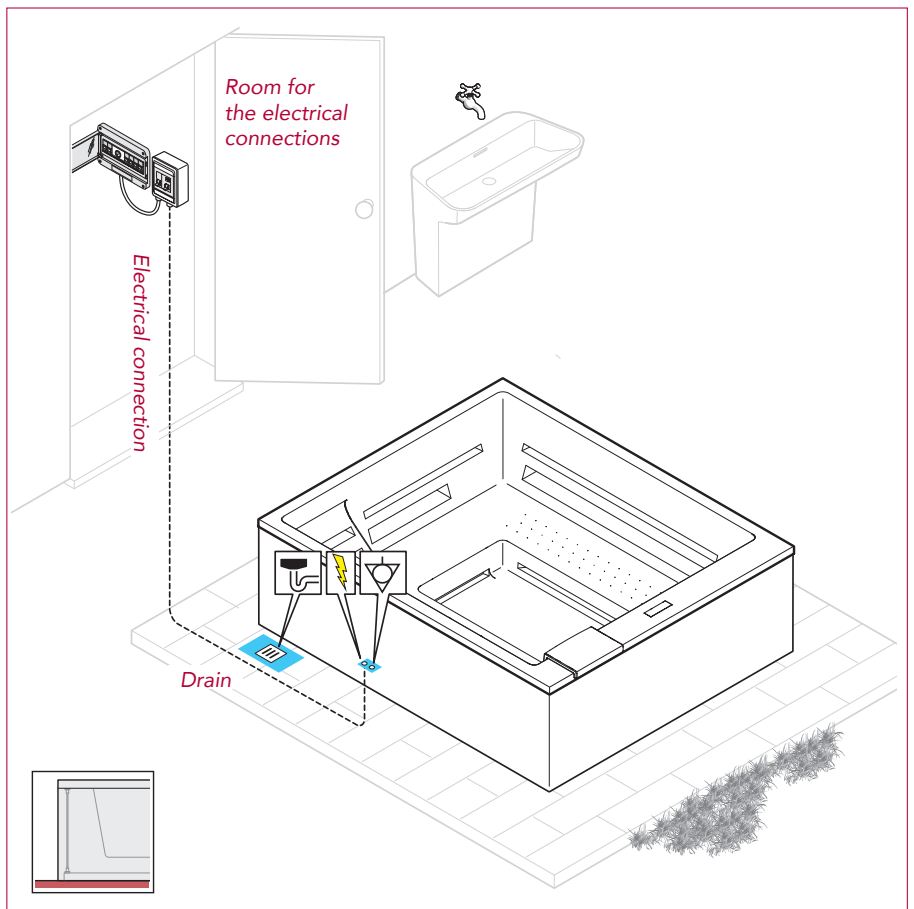

EXAMPLES OF OUTDOOR/INDOOR SPA INSTALLATION.

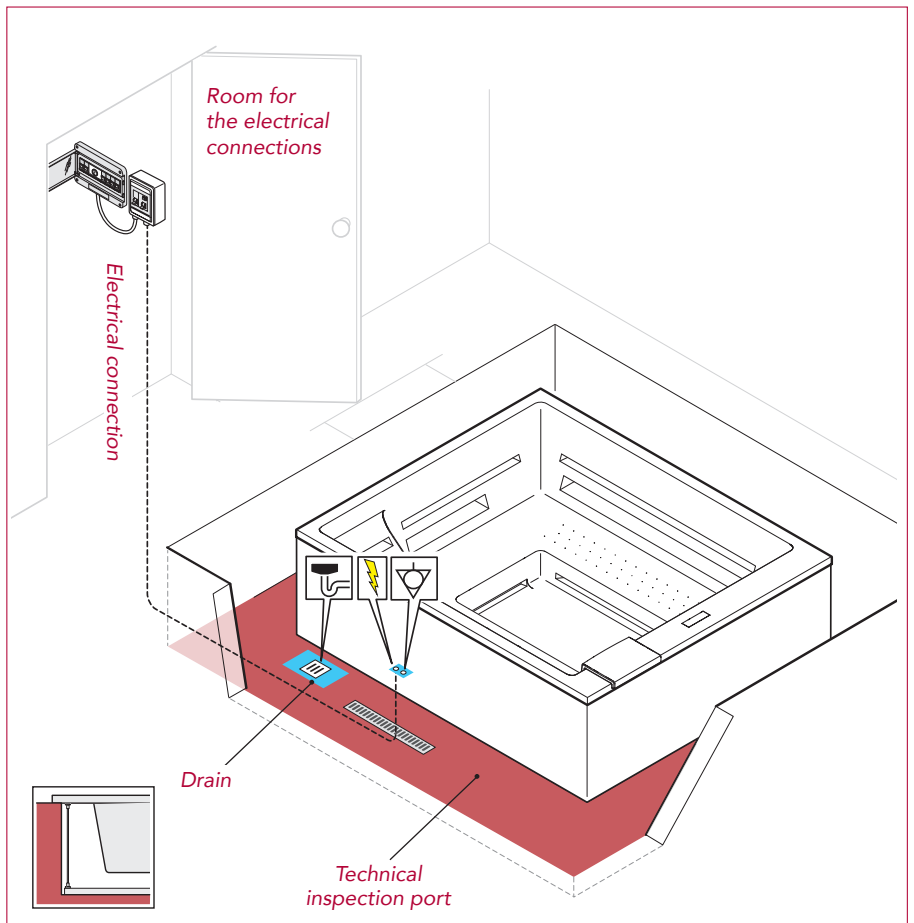

PREPARATION OF CONNECTION TO AN OPTIONAL EXTERNAL EXCHANGER (NOT SUPPLIED)

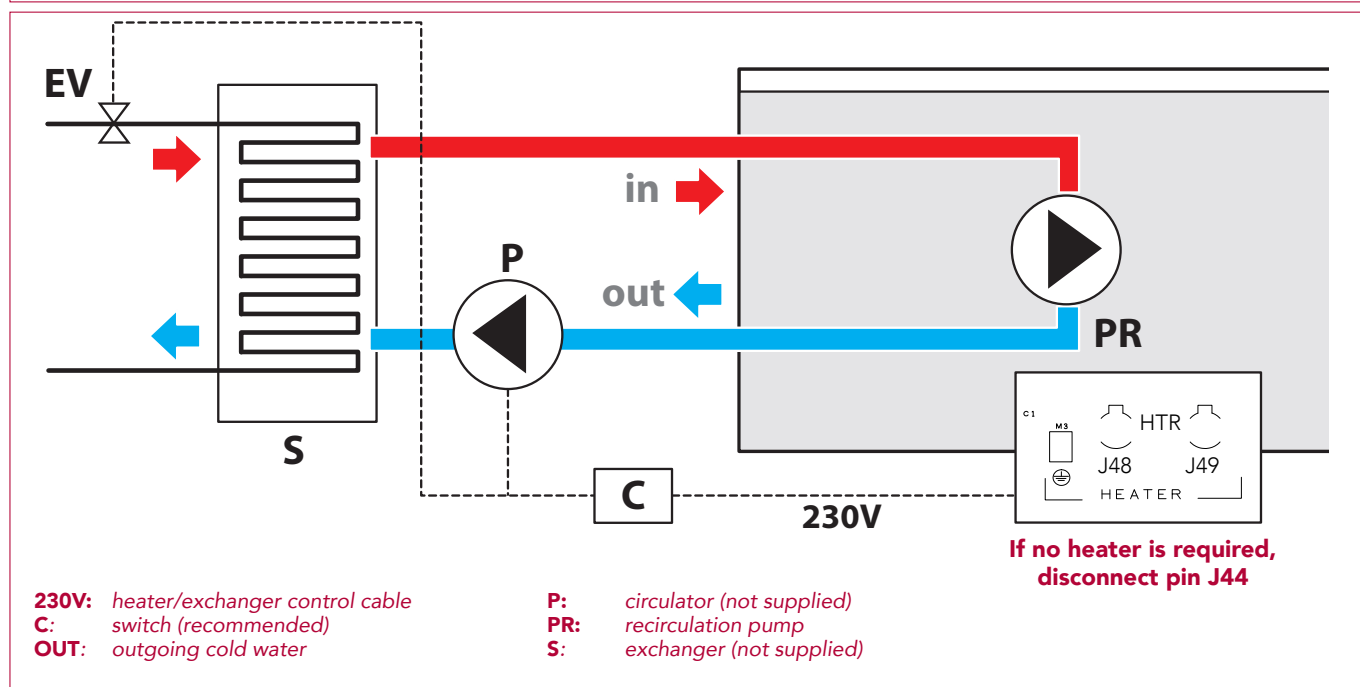
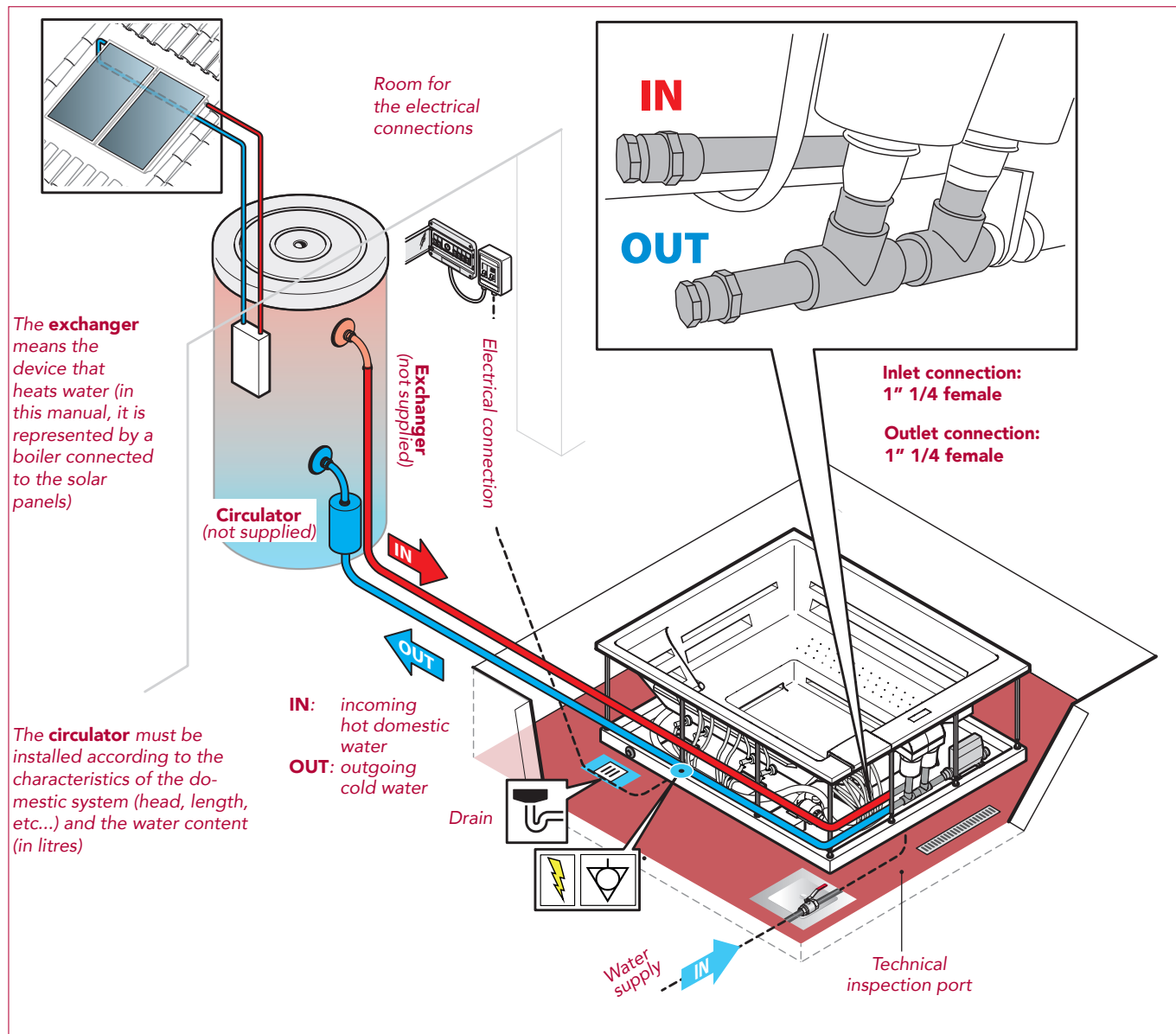

3 IDENTIFICATION OF THE INSTALLATION SITE

 When choosing the position, take into account the local regulations that prohibit any electrical installation (plug sockets, switches, lamps, etc.) in the area surrounding the spa for a distance of at least 60 cm and a height of 230 cm.

 When choosing the position, bear in mind that the inspection side (electrical/plumbing components side) must always remain accessible for future maintenance.

The recommended ambient temperature for the spa must be between -5°C and 45°C , with a relative humidity of 20-80%.

OUTDOOR INSTALLATION

Take into account the proximity of trees or hedges, and note that debris (e.g., leaves) can cause damage to the equipment over time that is not covered by warranty and make maintenance more expensive and frequent.

Also assess the best position to safeguard privacy and respect for others, as well as the best view or climatic position consistent with local regulations.

A sunny area with increased exposure during the morning ensures greater well-being for users!

 Consider the geological composition of the soil on which the supporting platform will be built. Soils that are very sandy, permeable or subject to flooding could compromise the durability of the spa's support platform.

INDOOR INSTALLATION

Note that the evaporation of water in the spa in the presence of high internal temperatures can generate very high levels of humidity in the environment.

To overcome this drawback, choose an environment with good natural or forced ventilation. As an alternative, install a dehumidification system. Humidity damage is not covered by the manufacturer warranty.

 Take into account the size of the spa: narrow passages, doors and steps can be an obstacle to its transport to the desired place.

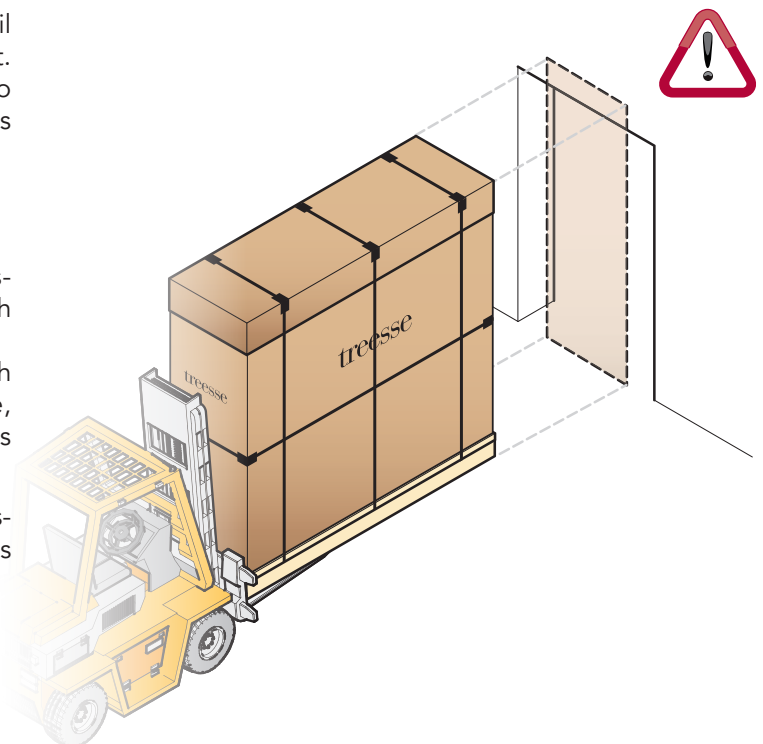
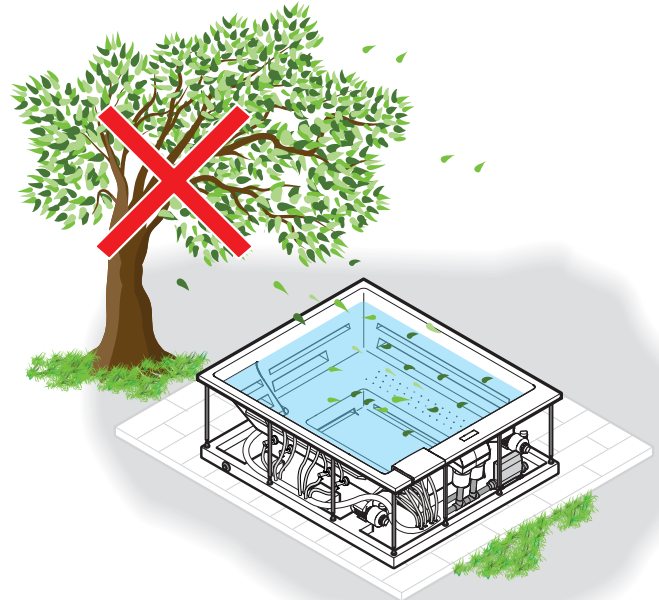

Tresse spas are built to be positioned outdoors.

If you install the spa inside, remember that it must be able to be easily inspected or moved for any ordinary and extraordinary maintenance operations.

4

PREPARATION OF THE INSTALLATION SITE



Before preparing the supporting surface, **see the sections on the electrical connections** for positioning the connections correctly.

FREESTANDING INSTALLATIONS

As a base, build a platform or flooring in reinforced concrete, at least 10 cm thick, perfectly flat and suitable for supporting the weight of the spa and the people using it. The manufacturer suggests a minimum load of 450 kg/m². In any case contact a qualified construction engineer to calculate the appropriate load for the installation site.



Wedges or shims cannot be placed under the spa to level it.

Remember to ground the structural reinforcement in accordance with electrical codes.



Prepare:

- **A** drainage grating around the perimeter to help preserve the equipment and the structure (even for indoor installations).
- **B** A non-slip flooring around the spa.



For the preparation of the electrical connections see the pertinent chapter on page 12.

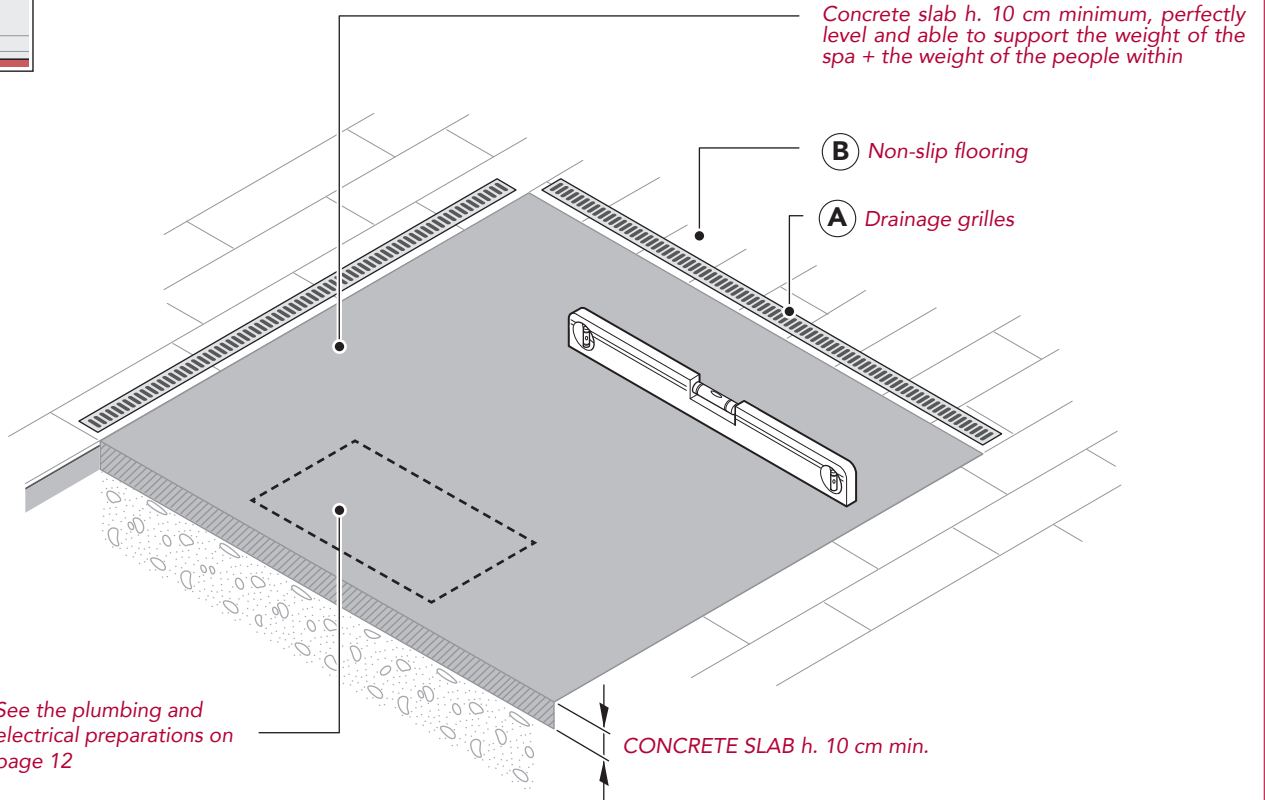
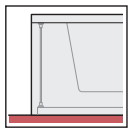

BUILT-IN INSTALLATIONS

As a base, create a reinforced concrete recess having a thickness of at least 10 cm, perfectly flat and able to support the weight of the spa and the people using it (the Manufacturer recommends a minimum load of 450 kg/m²). In any case contact a qualified construction engineer to calculate the appropriate load for your installation site.



Wedges or shims cannot be placed under the spa to level it.

Remember to ground the structural reinforcement in accordance with electrical codes.

Prepare:

- **(A)** A technical inspection port* at least 50 cm wide on all sides of the spa. This will make future maintenance or repairs easier.
- **(B)** drainage grating around the perimeter and in the recess to help preserve the equipment and the structure (even for indoor installations).
- **(C)** A non-slip flooring around the spa.
- **(D)** Two Ø15 cm vents to ensure proper ventilation and extraction of the heat and moisture from the technical compartment.

FOR THE RECESSED OUTDOOR INSTALLATIONS, to avoid damage due to freezing we recommend insulating **(E)** the spa recess. This procedure prevents excessive condensation that over time cause odours and damage to all major internal components. The choice of materials and thickness should be based on the minimum temperatures reached in the country of installation.



For the preparation of the electrical connections see the pertinent chapter on page 12.

**If it was not possible to provide a technical inspection port on all sides of the spa, a pneumatic lift is available (optional - to be requested from the Manufacturer) in order to simplify future maintenance operations. It is recommended to provide a removable inspection hatch*

"A" positioned on the side where the spa components are situated. Regarding the installation and use of the lifter, refer to its technical sheet and manual.

After positioning the spa in its prepared space and after having connected the lift, test it.

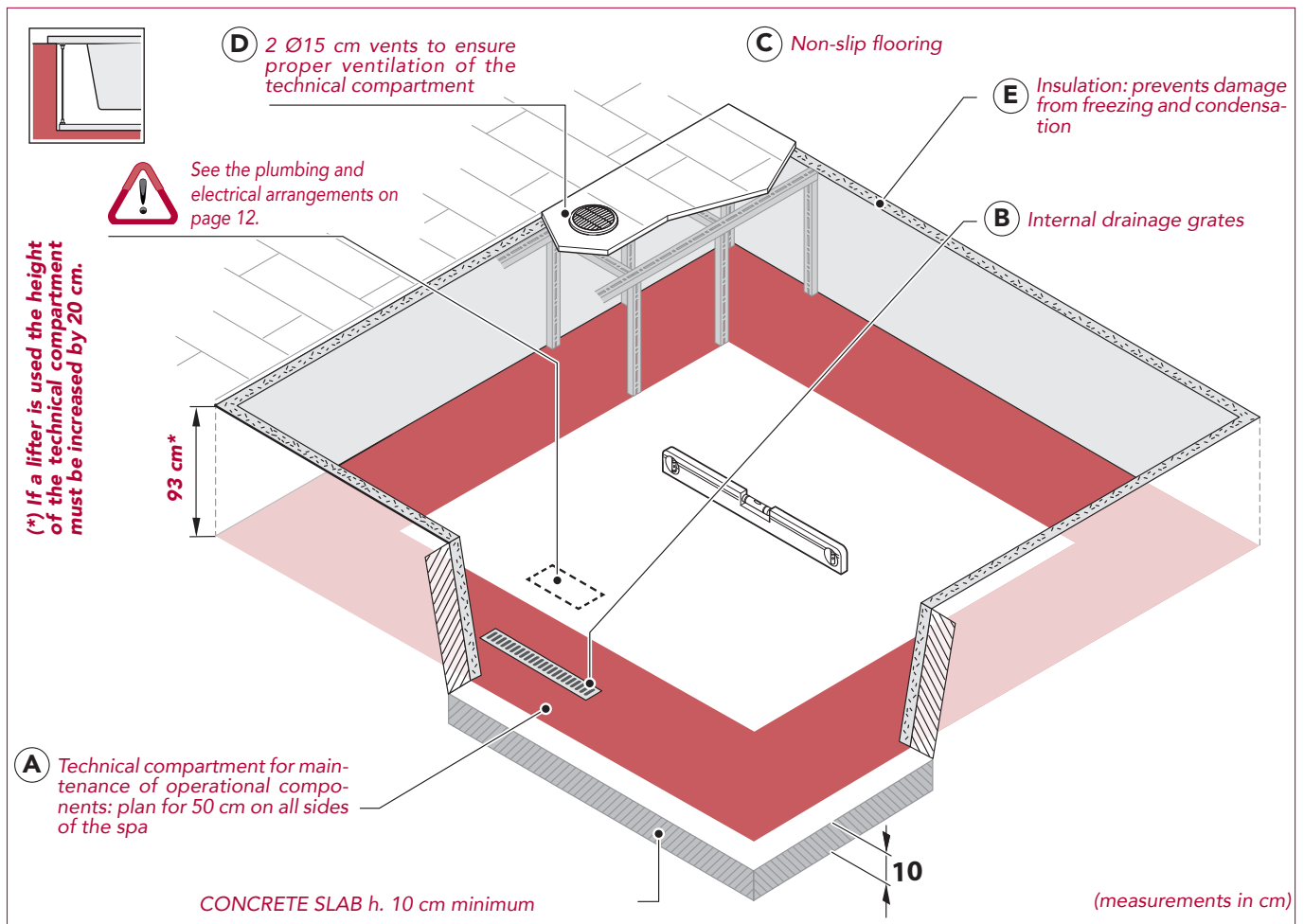
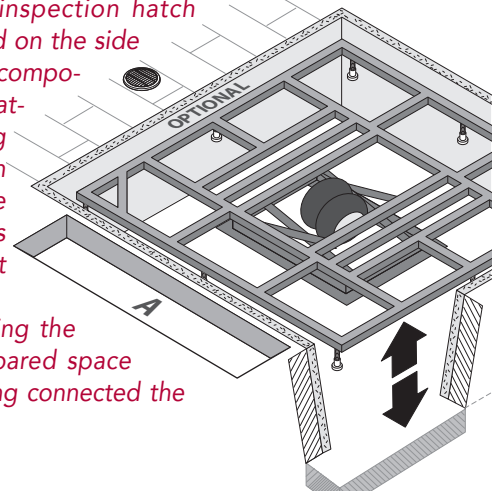

5 CHARACTERISTICS OF THE WATER SUPPLY



More information

TAP WATER AND WELL WATER

To ensure maximum hygiene and durability of the spa it is essential to pay close attention to the quality of the water that will be used to fill it. It is important that the water used be drinkable. It is always advisable not to use well water because it may be very hard, rich in metals like iron and manganese, and have bacterial loads. Tap water is recommended.

In the case of very hard or ferrous water it is always recommended to install softening and iron removal systems upstream.

The company cannot be held responsible for issues related to the use of non-drinkable water or lack of installation of such systems.

The plumber is responsible for choosing the type of components to be used and the verification of compliance with the purity and potability parameters of the water supply.

WATER HARDNESS

Water hardness (TH) is determined by the total content of calcium and magnesium present in the water, coming from their soluble salts.

Water classification:

.....up to 7°f = Very soft water
 From 7°f to 14°f = Soft water
 From 14°f to 22°f = Slightly hard water
 From 22°f to 32°f = Fairly hard water
 From 32°f to 54°f = Hard water
more than 54°f = Very hard water
 (1°f = 10 mg calcium carbonate per litre of water)

WATER ALKALINITY

Alkalinity (CAT) represents the concentration of bicarbonate ions present in the water. It is expressed as mg/L of calcium carbonate or in French degrees (°F). Ideal values of alkalinity range between 80 mg/L and 125 mg/L (8°F-12.5°F). Values outside of this range can more easily cause variations of the pH. Instead, alkalinity within the range noted makes it possible to "buffer" the pH value, resulting in fewer abrupt variations.

WATER PH

What is pH?

The pH is a chemical parameter that gives an idea of the acidity or basicity of the water. It can assume values between 0 and 14. By definition water is considered neutral if its pH is equal to 7. It is acidic if the pH is lower than 7 and basic if the pH is greater than 7. Disinfectants have an ideal pH at which they are most effective. In the case of heated water treated with bromine products it is recommended to keep the pH value in the range from 7.4 to 7.8 using chemical correctors as needed if the pH is higher or lower to bring the pH value back to the recommended interval.

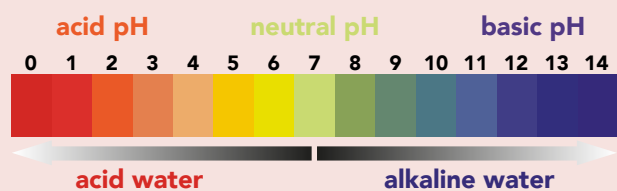

CHARACTERISTICS OF THE WATER SUPPLY

PARAMETER	OPTIMAL VALUES between...	VALUES ABOVE OR BELOW CAN...
POTABILITY	Refer to the specific regulations of the country of use	...cause problems related to the safety and well-being of users
HARDNESS (TH)	between 10°F and 25°F (100 mg/l-250 mg/l)	...cause build-up that over time can cause damage to the walls of the spa, the pipes, the filter system, as well as the heating unit and pumps. The limescale deposits can also hide bacterial loads that are not easily reached by disinfectant products. Installation mandatory. It is mandatory to install a <u>cation exchange resin water softener</u> , choosing the model according to the hardness of the water.
pH	for bromine treatments it is recommended to keep the pH in the range 7.4 to 7.8	...irritation of the eyes and skin of people in the water, water with little sanitising power, excessive consumption of chemicals, decrease in the duration of the spa components.
ALKALINITY (CAT)	80 and 125 mg/l (8-12.5°F)	...more likely uncontrollable changes in pH

6 ELECTRICAL PREPARATIONS

The Tressse spas are built in compliance with UL laws (XXXXXXXX) and are tested during production to ensure the safety of the installer and user.

The connection must be made by an experienced, qualified electrician.

a) READ AND FOLLOW ALL INSTRUCTIONS.

b) A green coloured terminal or a terminal marked G, GR, Ground, Grounding, or the symbol* is located inside the supply terminal box or compartment. To reduce the risk of electric shock, this terminal must be connected to the grounding means provided in the electric supply service panel with a continuous copper wire equivalent in size to the circuit conductors supplying this equipment. * IEC 60417, Symbol 5019.

c) At least two lugs marked "BONDING LUGS" are provided on the external surface or on the inside of the supply terminal box or compartment. To reduce the risk of electric shock, connect the local common bonding grid in the area of the hot tub or spa to these terminals with an insulated or bare copper conductor not smaller than No. 6 AWG.

d) All field-installed metal components such as rails, ladders, drains, or other similar hardware within 3 m of the spa or hot tub shall be bonded to the equipment grounding bus with copper conductors not smaller than No. 6 AWG.

e) SAVE THESE INSTRUCTIONS.



The Manufacturer is not responsible for connections made in a way that does not comply with local codes, the specifications in this manual or tampering with any electrical component of the spa.

WARNING – This product is provided with a ground-fault circuit-interrupter (give location). The GFCI must be tested before each use. With the product operating, open the service door. When the product stops operating, this merely indicates that the door is equipped with an electrical interlock. Next, push the test button on the GFCI and close the service door. The product should not operate. Now open the service door, push the reset button on the GFCI and close the service door. The product should now operate normally. When the product fails to operate in this manner, there is a ground current flowing indicating the possibility of an electric shock. Disconnect the power until the fault has been identified and corrected.



Local regulations prohibit any electrical installation (plug sockets, switches, lamps, etc.) in the area surrounding the spa for a distance of at least 60 cm and a height of 230 cm.

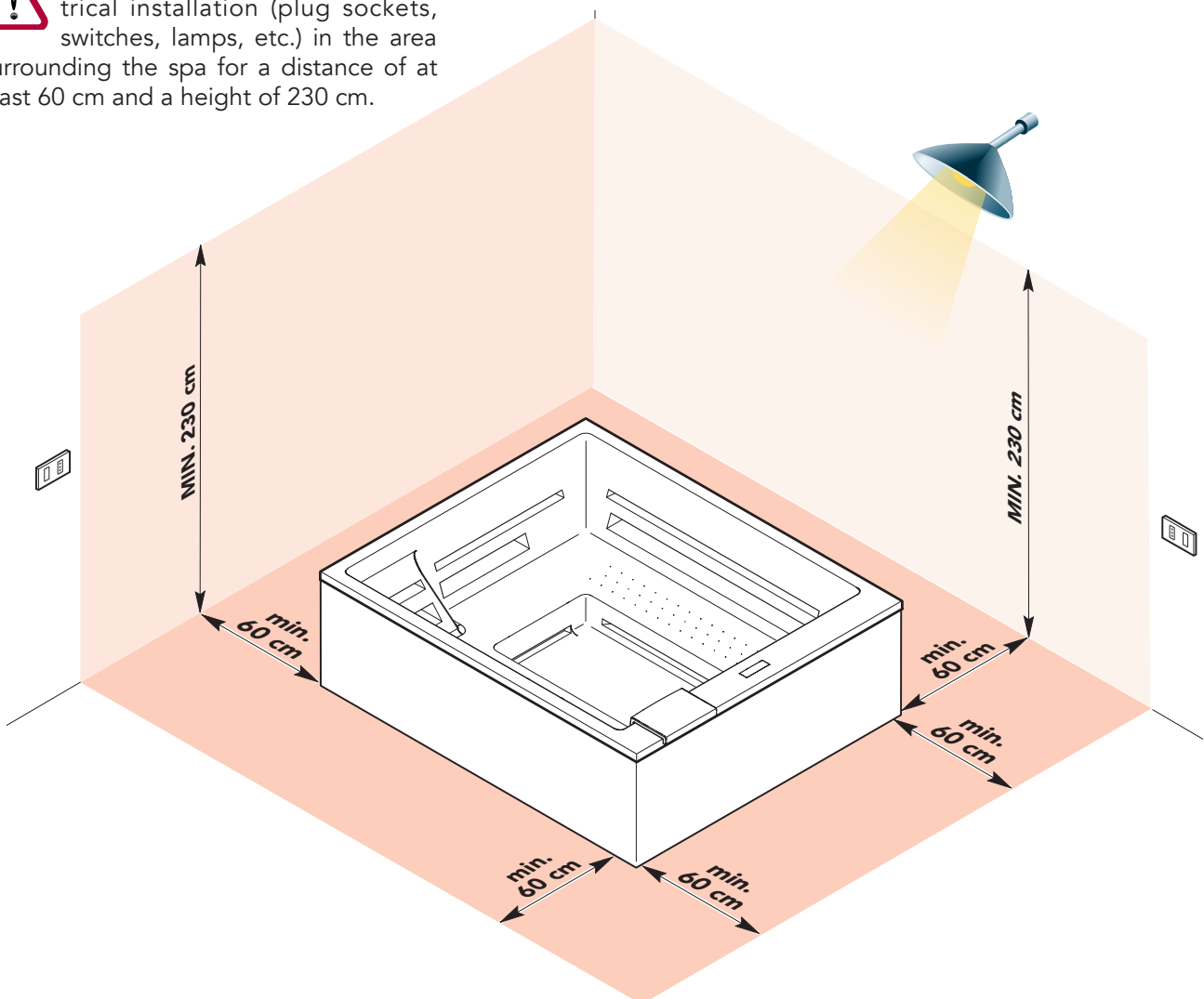

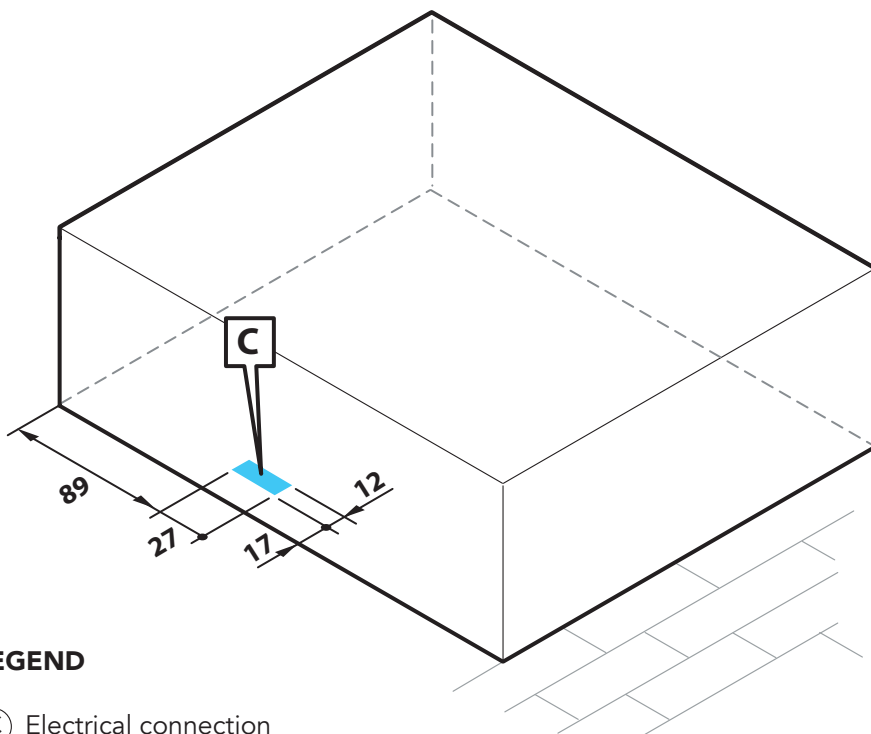

LEGEND

- Ⓒ Electrical connection
Exchanger pipe connection (if included)

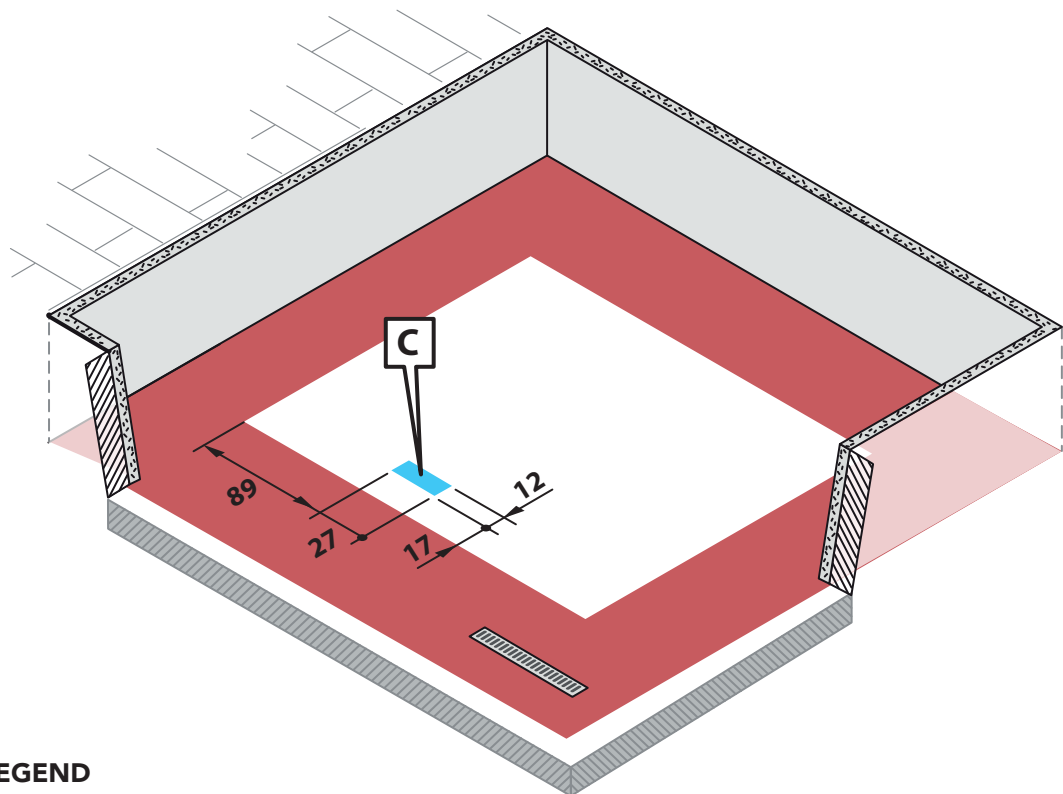

LEGEND

- Ⓒ Electrical connection
Exchanger pipe connection (if included)

(measurements in cm)



THE IMAGE SHOWN HERE IS REPRESENTATIVE ONLY: MAKE THE ELECTRICAL CONNECTIONS FOLLOWING EXCLUSIVELY THE DIAGRAM (electrical diagram) SHOWN UNDER THE COVER OF YOUR CONTROL UNIT.

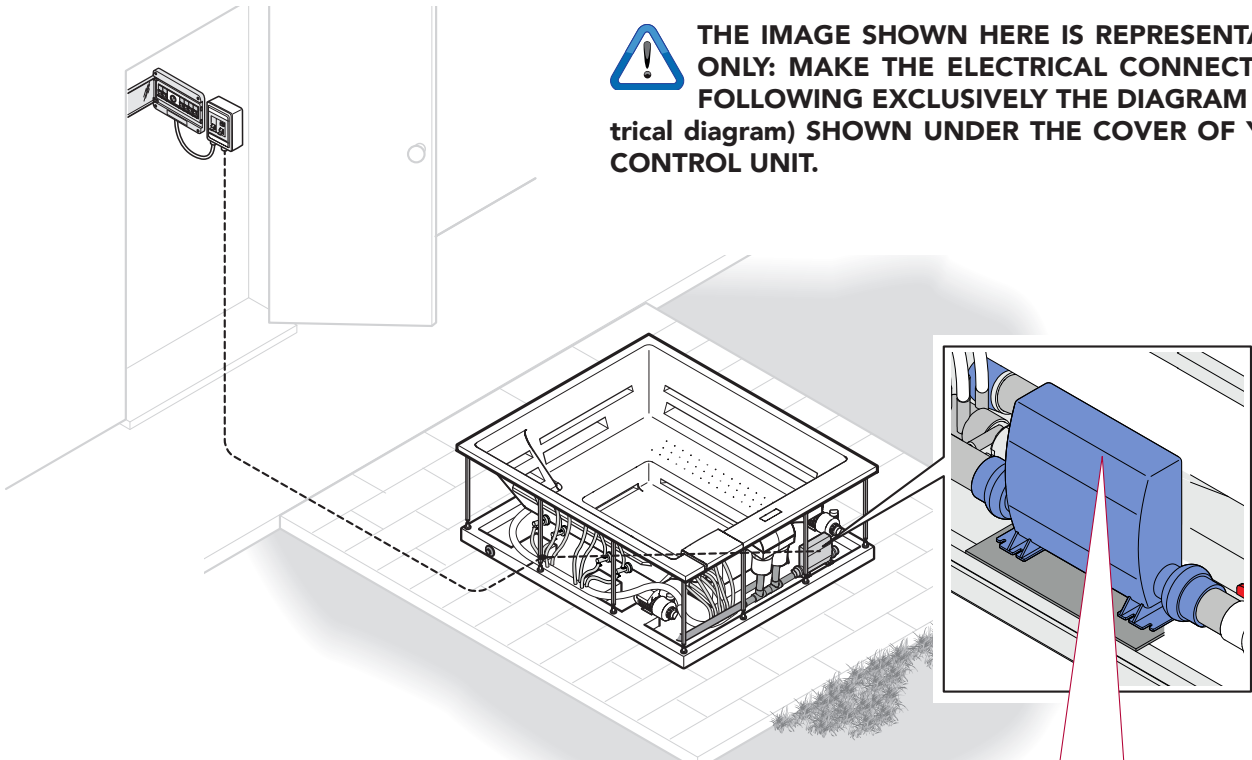

J43 TO J13 (BLOWER ON J14)
IN SETUPS 3, 5, 9, 11, 12, 17, 18

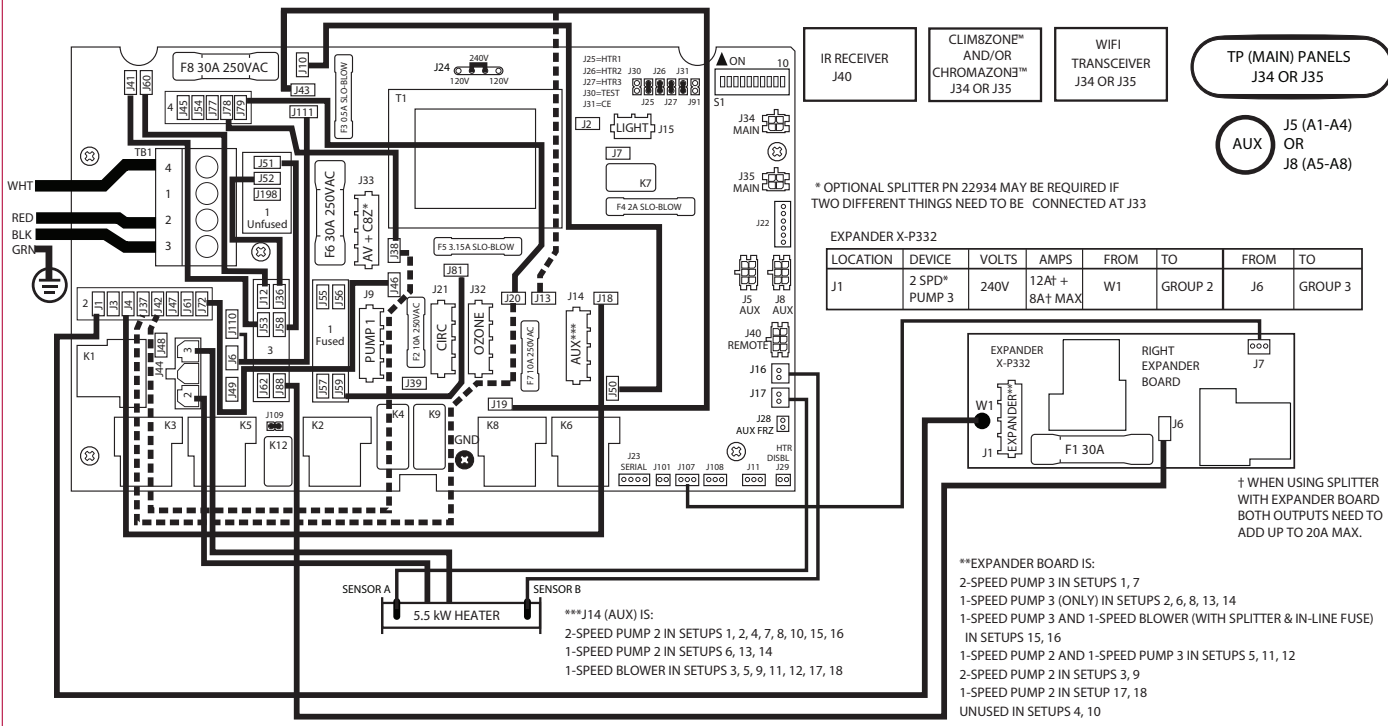

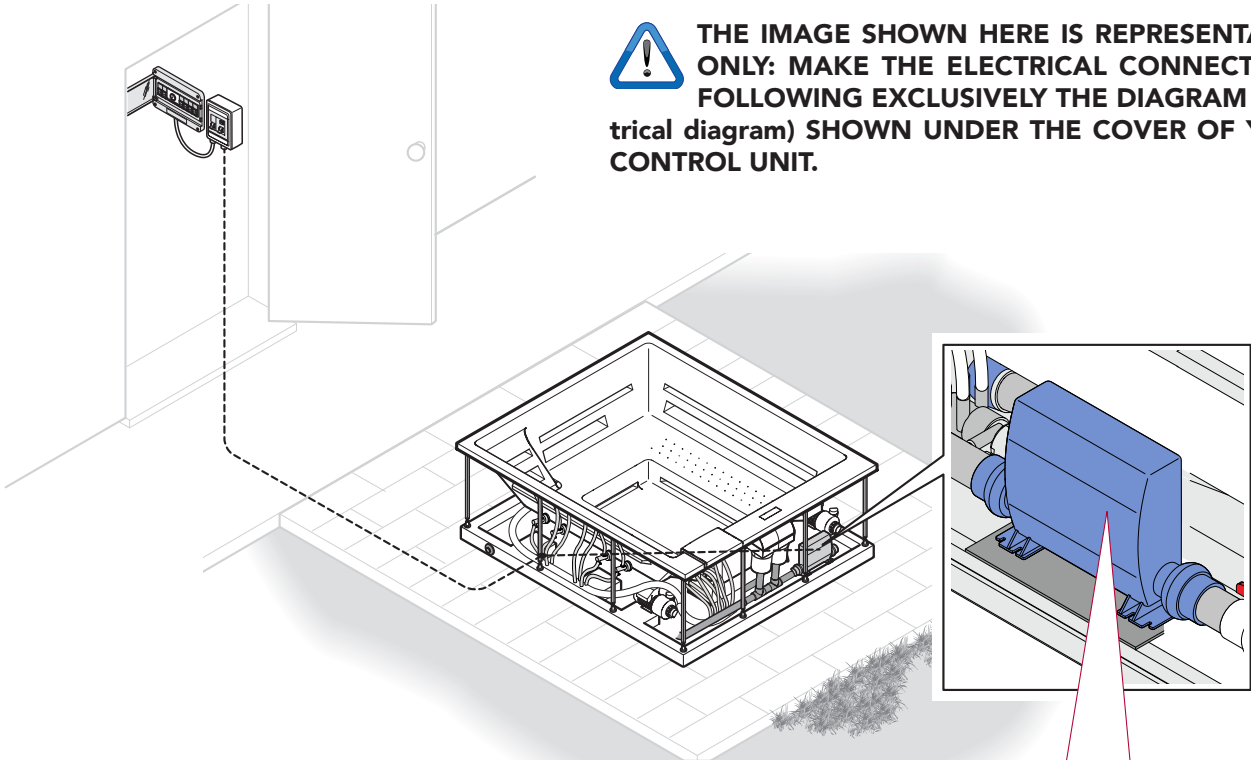

THE IMAGE SHOWN HERE IS REPRESENTATIVE ONLY: MAKE THE ELECTRICAL CONNECTIONS FOLLOWING EXCLUSIVELY THE DIAGRAM (electrical diagram) SHOWN UNDER THE COVER OF YOUR CONTROL UNIT.

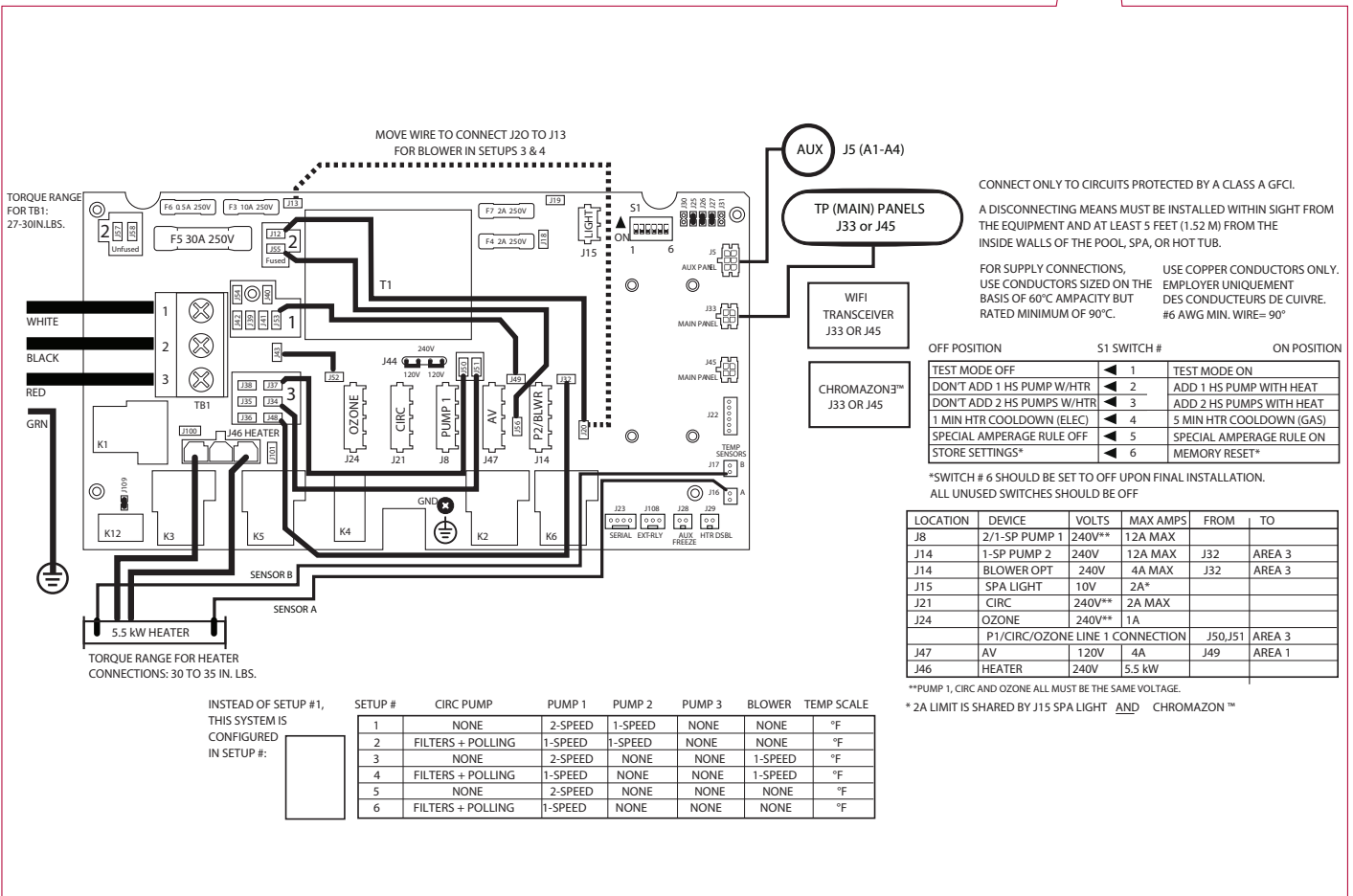

Maximum care has been paid to guarantee the accuracy of this manual.
The Manufacturer reserves the right to modify the equipment or the documentation at any time, without notice.
Therefore, there might be small differences between this manual and the product you have received: we apologise in advance for any inconvenience.
The total or partial reproduction of this manual without the Manufacturer's consent is prohibited. Measurements are purely indicative and not binding.
The original language of this manual is Italian: the Manufacturer is not responsible for any mistakes in translation/interpretation.

treesse

www.gruppotreesse.it

GRUPPO TRE S.p.a.
01036 Nepi (VT) - Italy
S.S. Cassia km. 36.400
Settevene industrial area
tel. (+39) 0761 527242
fax (+39) 0761 527223
info@gruppotres.it